

this activity workbook belongs to:

from the town of:

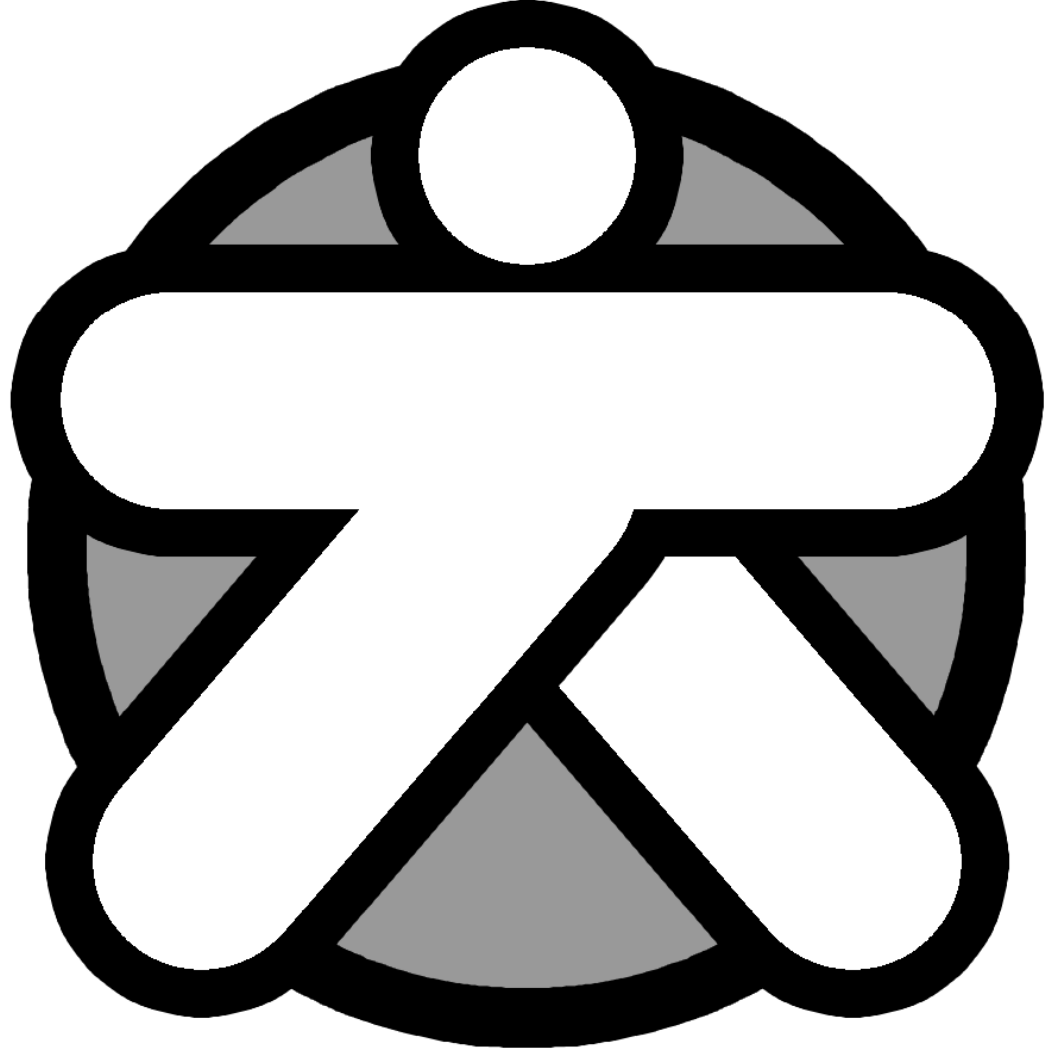

# ASTEBK

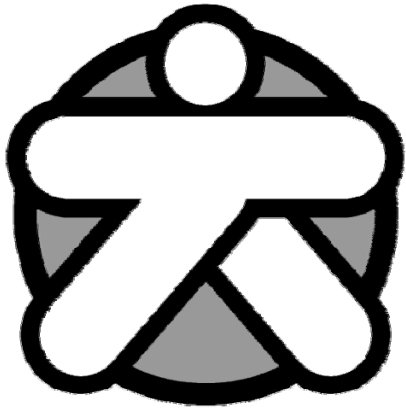

ASTEK is the honored recipient of the 2000 AIAS National Special Accomplishment Award.



ASTEK is sponsored by the Oklahoma State University chapter of the American Institute of Architecture Students, a non-profit, student-run national organization.

The Oklahoma State University chapter of the American Institute of Architecture Students (AIAS) is proud to offer an educational contribution to local elementary schools and communities. As students of the School of Architecture at Oklahoma State University, we are taught how to improve the quality of life for our communities by improving the built environment that surrounds us everyday. However, this appreciation does not have to be limited to architectural design studios.

By reaching out to children in education, the ASTEK program strengthens existing curriculum and spreads an awareness of the everyday surroundings. Through these activities we stimulate students' imaginations in new ways using things they see everyday, but may not have noticed. We hope that these ideas may help improve our communities and the quality of life for the future.

MISSION STATEMENT

A Story and Visualization Exercise	①
Textures and Materials	②
Urban Planning	③
Scale and Sketching	④
Geometry in Architecture	⑤
The Architect's Floor Plan	⑥
Structures in Architecture	⑦
Beginning Building	⑧
Finish Building	⑨
Gallery Show	⑩

## LESSON 1

One of the most important skills an architect must have is the ability to visualize what their client is describing and draw it for them.

As a class, choose words for the following topics to fill in the blanks of the story.

Town name:

A Shape:

A Color:

A Plural Noun:

During this lesson try really hard to listen to the details of the story and draw what you see.

**Architecture:** the science and art of designing and constructing buildings, or other structures for human habitation and interaction.

**Architect:** a person whose job is designing and creating drawings for built structures.

**Visualize:** to form a mental image of something without seeing it.

**Interpret:** to translate ideas into understandable forms.



Below them, [town name] was laid out in harsh angular patterns. The houses in the outskirts were all exactly alike, small [shape] boxes painted gray. Each had a small, rectangular plot of lawn in front, with a straight line of dull-looking flowers edging the path to the door. Meg had a feeling that if she could count the flowers there would be exactly the same number for each house. In front of all the houses children were playing. Some were skipping rope, some were bouncing [color] balls. Meg felt vaguely that something was wrong with their play. It seemed exactly like children playing around any housing development at home, and yet there was something different about it. She looked at Calvin, and saw that he, too, was puzzled.

“Look!” Charles Wallace said suddenly. “They’re skipping and bouncing in rhythm! Everyone’s doing it at exactly the same moment.”

This was so. As the skipping rope hit the pavement, so did the [color] ball. As the rope curved over the head of the jumping child, the child with the [color] ball caught the [color] ball. Down came the ropes. Down came the [color] balls. Over and over again. Up. Down. All in rhythm. All identical. Like the houses. Like the paths. Like the flowers.

Then the doors of all the houses opened simultaneously, and out came women like a row of [noun]. The print of their dresses was different, but they all gave the appearance of being the same. Each woman stood on the steps of her house. Each clapped. Each child with the [color] ball caught the [color] ball. Each child with the skipping rope folded the rope. Each child turned and walked into the house. The doors clicked shut behind them.

Adapted from:

A Wrinkle in Time

by Madeleine L'Engle 1973

**Assignment:**

Using a pen, pencil, markers, crayons, etc. draw as many details from the story as possible in the space to the right. Your drawing(s) do not have to be 'perfect' just try to draw what you see in your imagination.

No erasing.

Building of the Week:

The Sydney Opera House was designed by Jorn Utzon in 1973. It is composed of concrete panels covered in white ceramic tiles. Sydney, Australia was the site of the 2000 Olympic Games.

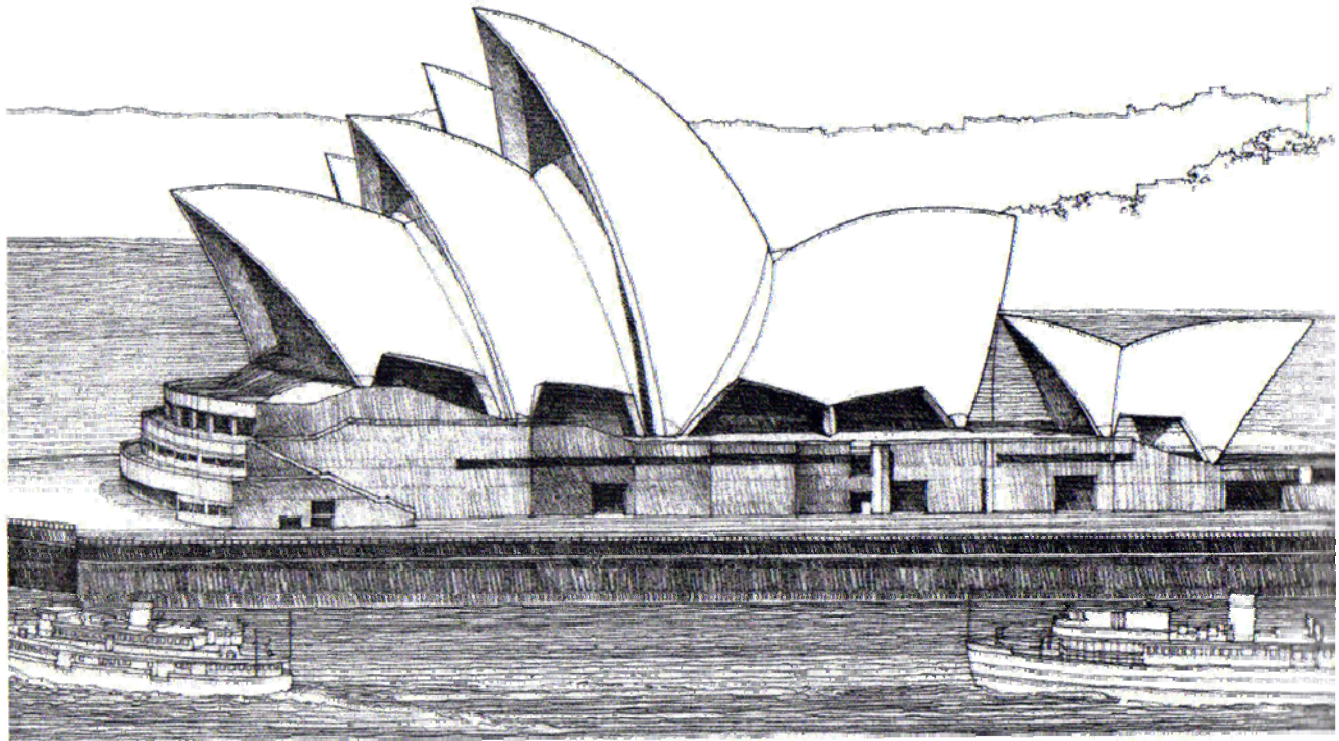

*Sydney Opera House, Sydney, Australia, designed 1957, completed 1973, Jorn Utzon*

Drawing by Francis  
Ching

## LESSON 2

Today you are going to learn about the different building materials and textures around your school. We will do this by making rubbings of different textures and comparing them. You are also going to learn about architectural rendering and some different techniques we use to achieve texture, shade and shadow on a drawing.

**Rendering:** a drawing, of a building or interior space, artistically showing the building materials, shades, and shadows.

**Crosshatching:** shading composed of two or more series of intersecting parallel lines.

**Shading:** the rendering of light/dark values in a drawing to create the illusion of 3-dimensionality & represent light/shadow.

**Scribbling:** shading by means of a network of random, multi-directional lines.

**Hatching:** Shading composed of fine lines drawn in close proximity.

**Stippling:** shading by means of dots, small spots, or short strokes.

**Assignment:**

Using a pen or marker recreate the rendering techniques in the spaces provided.

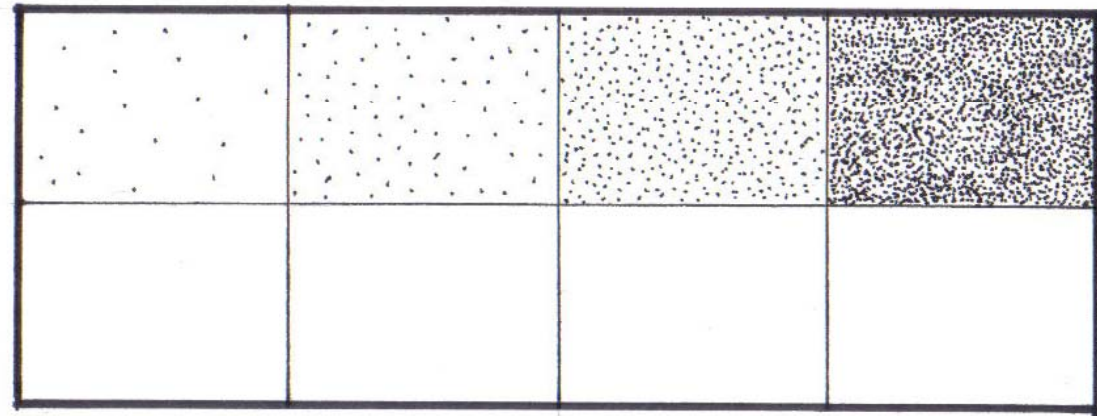
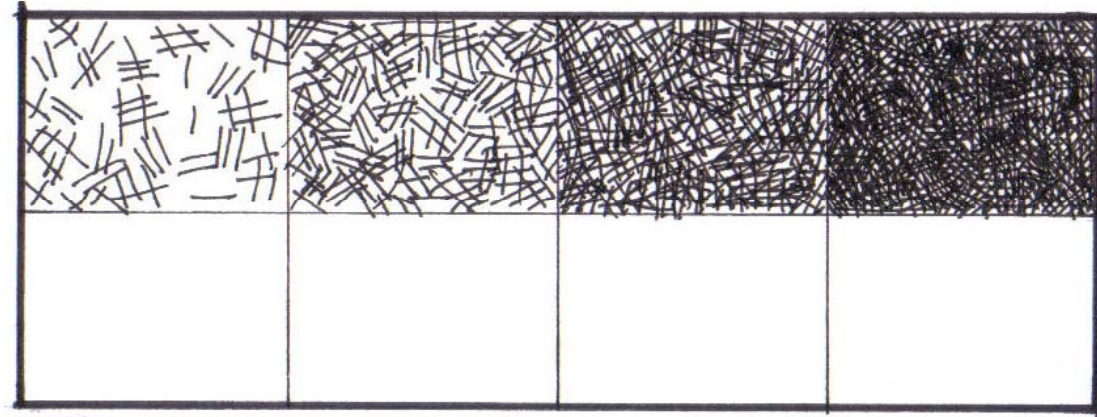
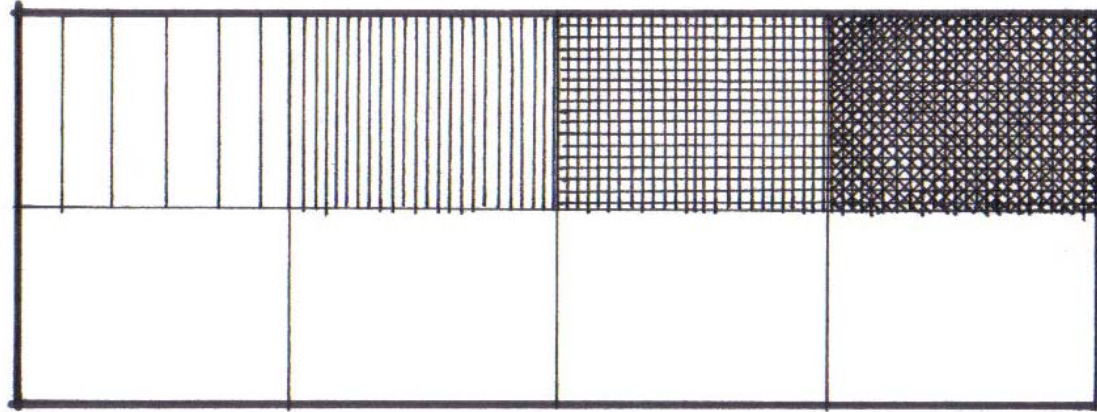



The two images to the right are examples of how one can use these rendering techniques. Notice how the stones appear to have different textures by using different techniques.

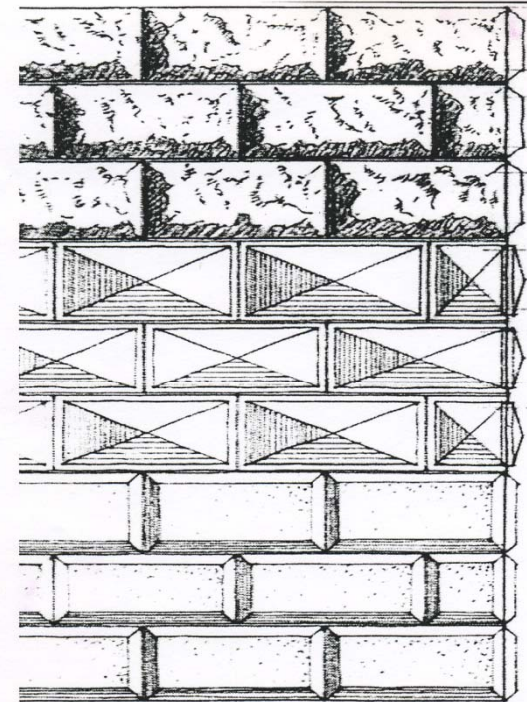
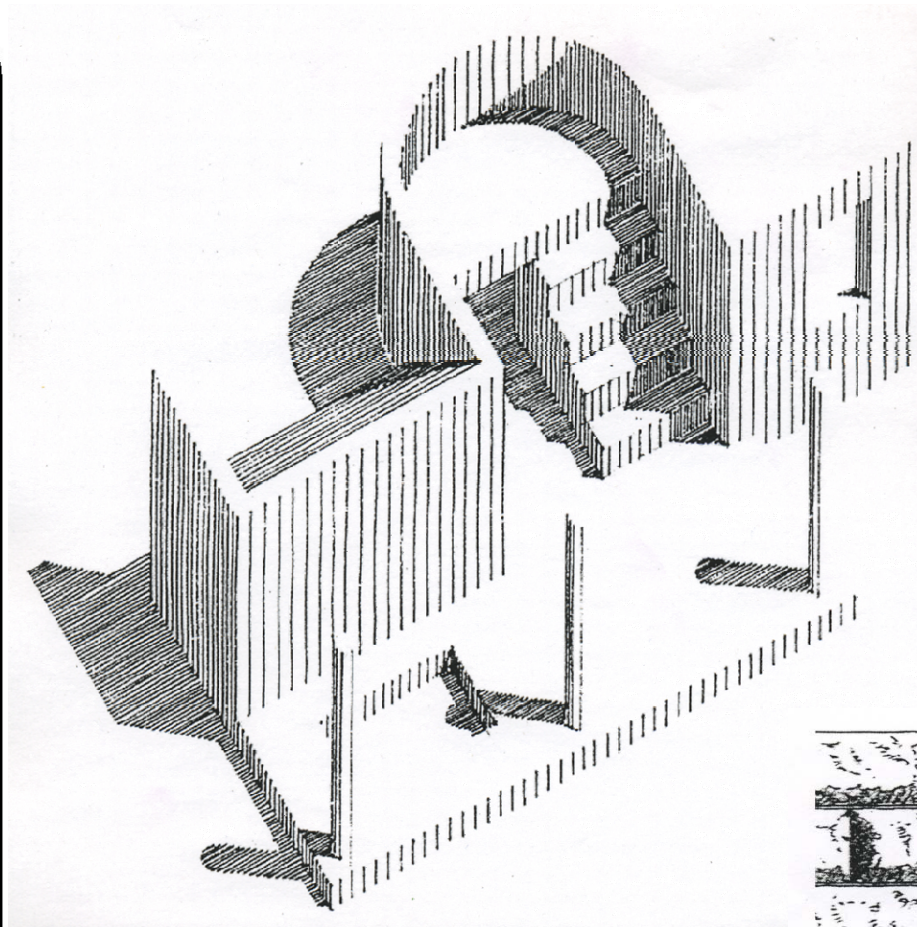

Drawings by Francis Ching

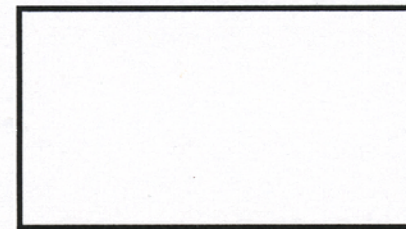
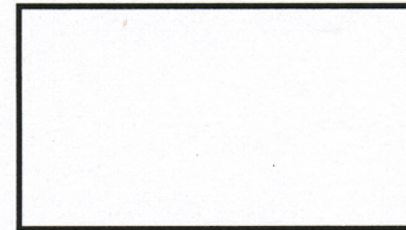
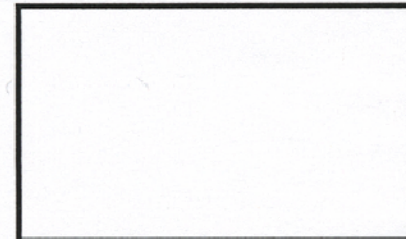
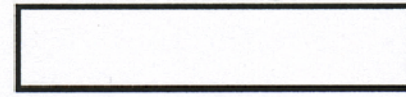
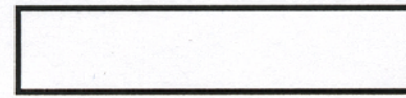
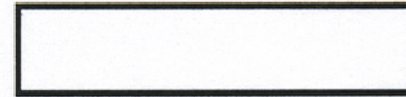
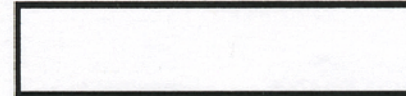
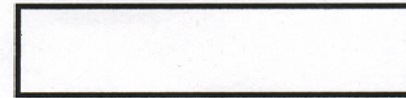
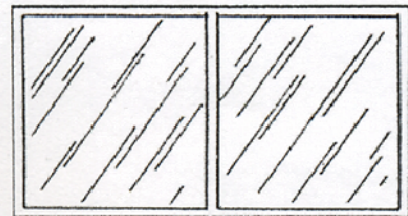
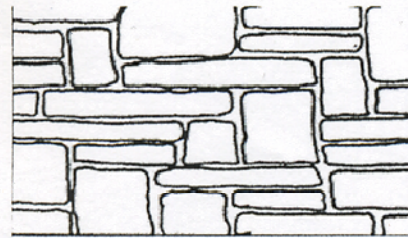
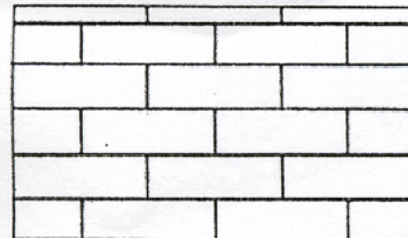
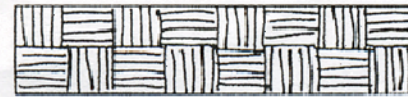
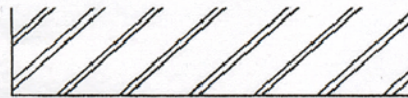
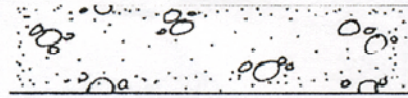

*Concrete*

*Stone*

*Wood*

*Steel*

*Earth*

*Brick*

*Stone*

*Glass*

### Assignment:

Using a pen or marker recreate these rendering techniques in the spaces provided.



### Assignment:

Using a crayon, make rubbings of materials around your school. Try to find all the materials that are labeled and then find three other materials that you think are interesting.

**brick**

**concrete**

**wood**

**tile**

**rubber**

**metal**



**Assignment:**

Using a crayon, make rubbings of materials around your school. Try to find all the materials that are labeled and then find three other materials that you think are interesting.

**glass**

**a sign**

**cloth**

Building of the Week:

St. Basil's Cathedral in Moscow, Russia was commissioned by Ivan the Terrible. It is located in the Red Square and was built in celebration of Ivan's many victories. It was constructed from 1550 to 1560 and since then it has been decorated with colored tiles to look oriental.



## LESSON 3

Today you are going to learn about how to plan your town. By studying zones that exist in our hometown we will determine how your ASTEK town should be laid out.

**Urban Planning:** the study or profession dealing with growth and functioning of cities and towns.

**Urban:** a city or town.

**Zoning:** the practice of organizing sections in a city according to their use. Ex: residential homes, parks, public businesses.

**Community:** a group of people living together that share common public interest in their city.

All cities should be planned out before they are built. This is done to better organize the city and the buildings in it and make residents safe and happy. Many cities use a grid system because it is easy for residents to understand.

After you get ready for school and leave the house, what is the first thing you do? Do you walk to the car, get on your bike, walk to the bus stop and wait for the bus, or do you walk by foot to school?

On your way to school what building or structures do you pass along the way? Do you pass houses, churches, schools, grocery stores, fire stations, restaurants, factories, or other types of business?

What other things do you notice?

### Assignment:

On the map to the right identify where you live, where your school is, the route you take to school and any significant buildings or spaces you pass along the way.

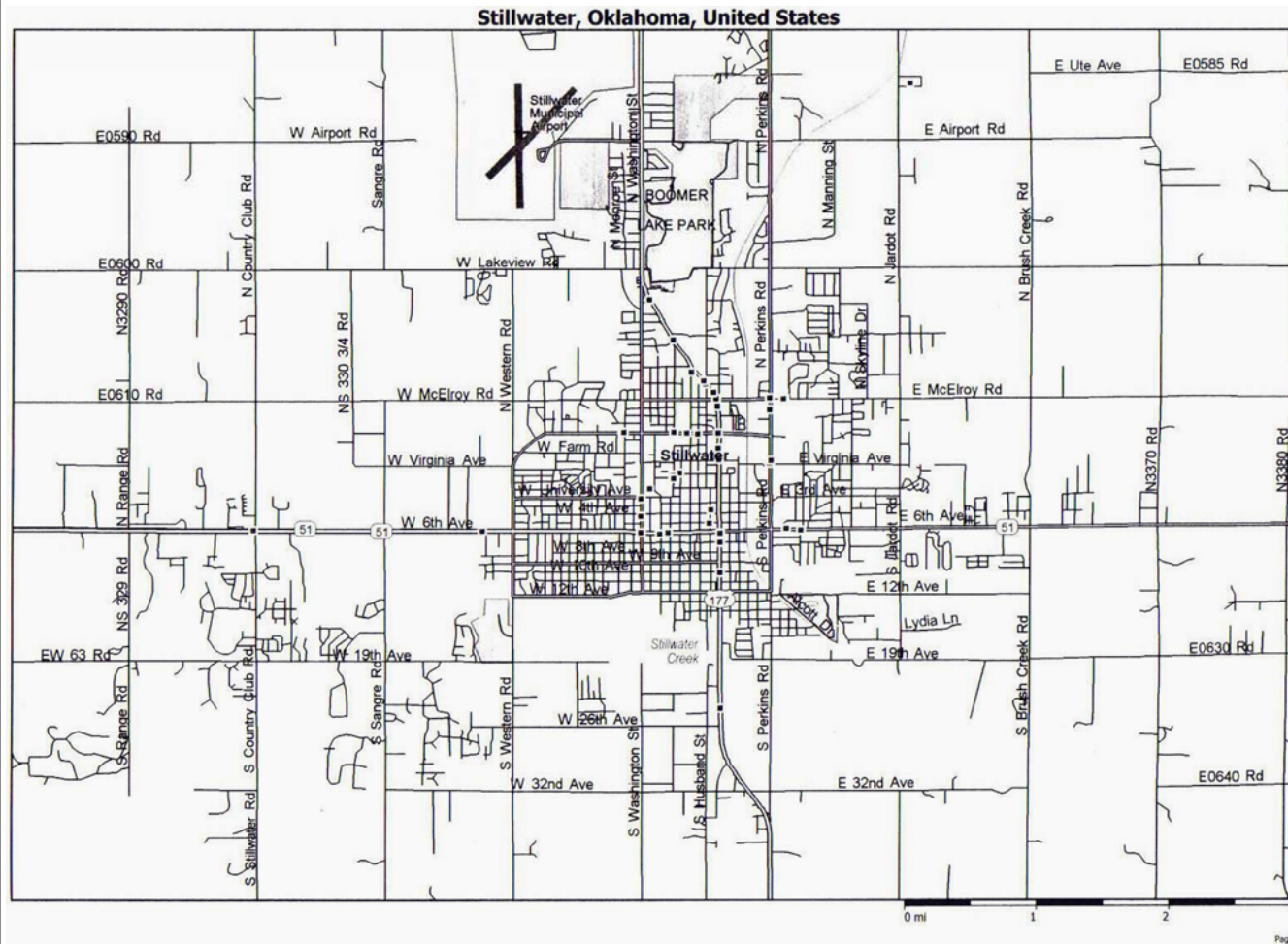

Here is a list of buildings you might see in your town. What others would you like to build?

- Fire Station
- Police Station
- Church
- Library
- City Hall
- Grocery Store
- Restaurant
- Gas Station
- Retail Store
- Bank
- Hospital
- Post Office
- School
- Houses
- Theater
- Park
- Museum
- Apartment Building

Here are some common examples of some of these buildings.



Here are some uncommon examples of very common buildings. These show that not all buildings have to look like the buildings you see everyday.

1. Chapel at Notre Dame-Du-Haut by Le Corbusier in Ronchamp, France 1955

2. Law Courts by Richard Rogers in Bordeaux, France 2001

3. Observatory Tower House by Sukumar Pal in Arizona desert

4. Milwaukee Art Museum by Santiago Calatrava in Milwaukee, Wisconsin 2001

5. Guggenheim Museum by Frank Lloyd Wright in NYC, New York 1943-59

6. Villa Savoye (a house) by Le Corbusier in Poissy, France 1931





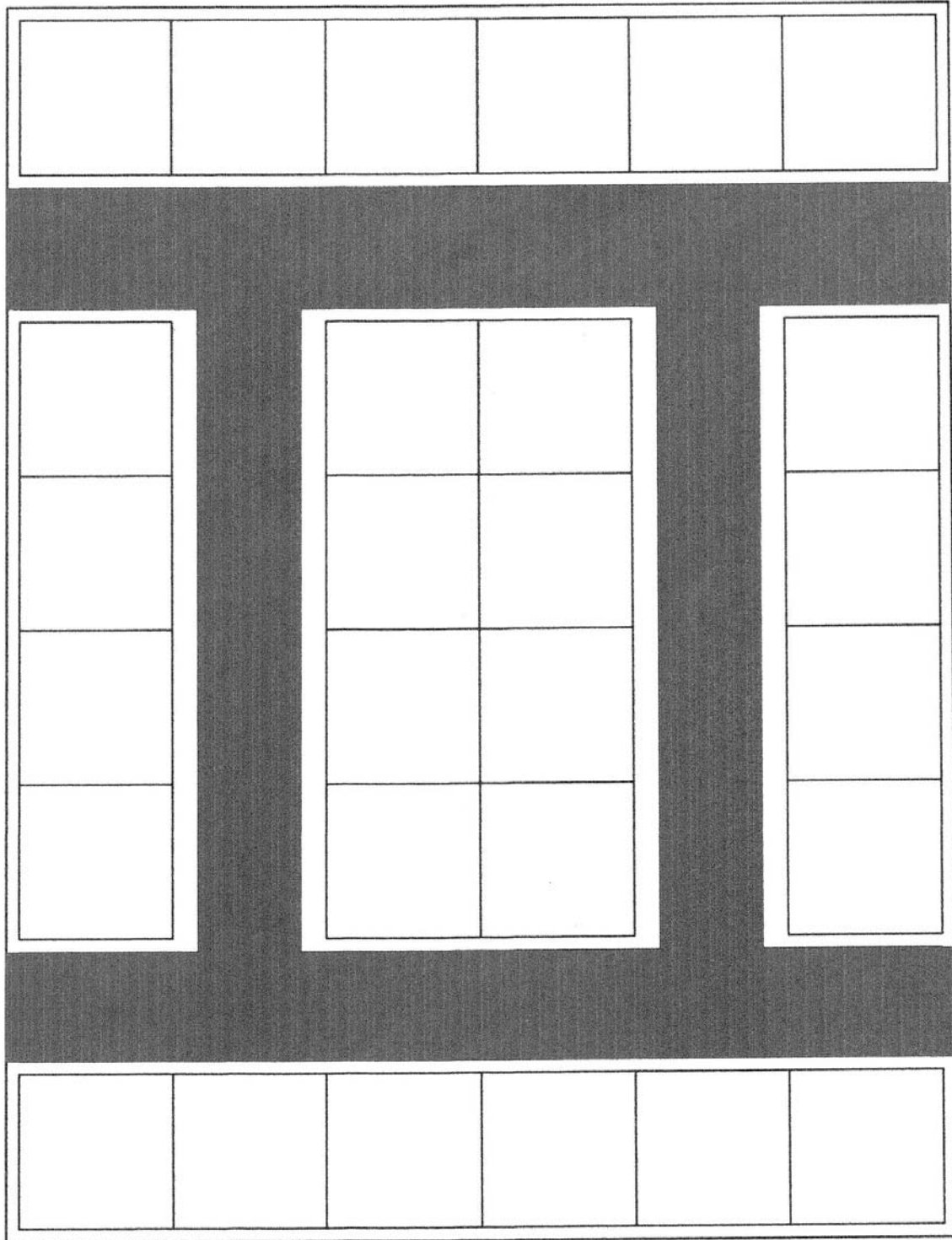

**Assignment:**

As your class discusses the layout of your city, label where each building will be on the city plan to the right.

### Building of the Week:

Seaside, Florida is an urban community located along the Gulf of Mexico, near Seagrove Beach. It was designed by Andres Duany and Elizabeth Plater-Zyberk. It is an 80 acre development, that was started in 1978.

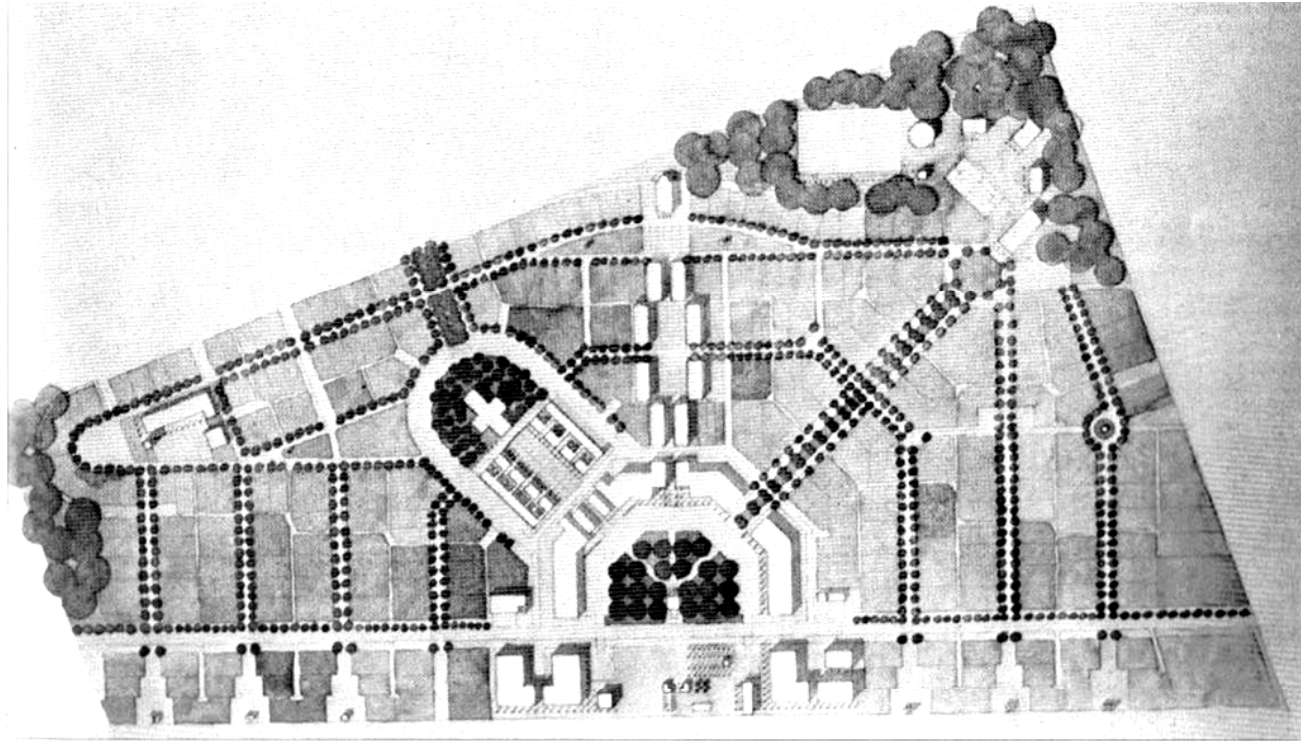



## LESSON 4

During this lesson you will learn the importance of scale and how it applies to architecture. You will also learn about sketching and even try sketching.

**Sketch:** a simple, quick drawing done quickly without much detail to describe something abstractly.

**Rendering:** a carefully detailed drawing completed to represent near reality.

**Scale:** a visual measurement based on proportions. Ex  $1/8''=1'$   $1/4''=1'$ .

**Human Scale:** using the proportion of a human to visually explain the size of a building or space.

The use of scale in architecture is very important. It can also be very misleading. The St. Louis Arch was designed by Eero Saarinen, and construction finished in 1965. These pictures of the arch show a variety of scales. The arch looks the biggest in picture 1 and looks the smallest in picture 4 because there is nothing near the arch to give you a scale to judge it by. The arch is 630 feet tall. [That's taller than two football fields long].

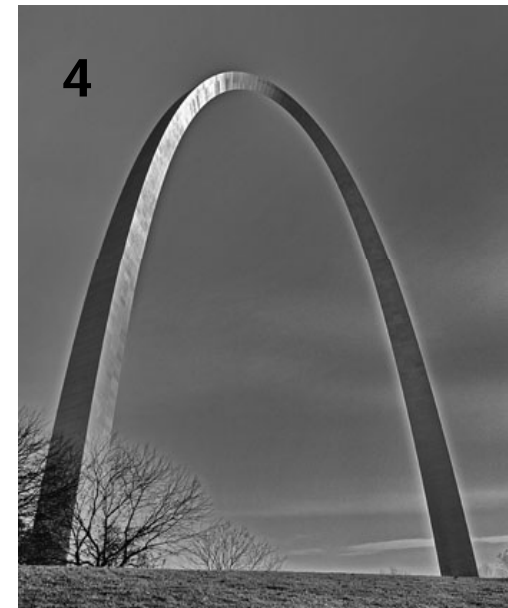
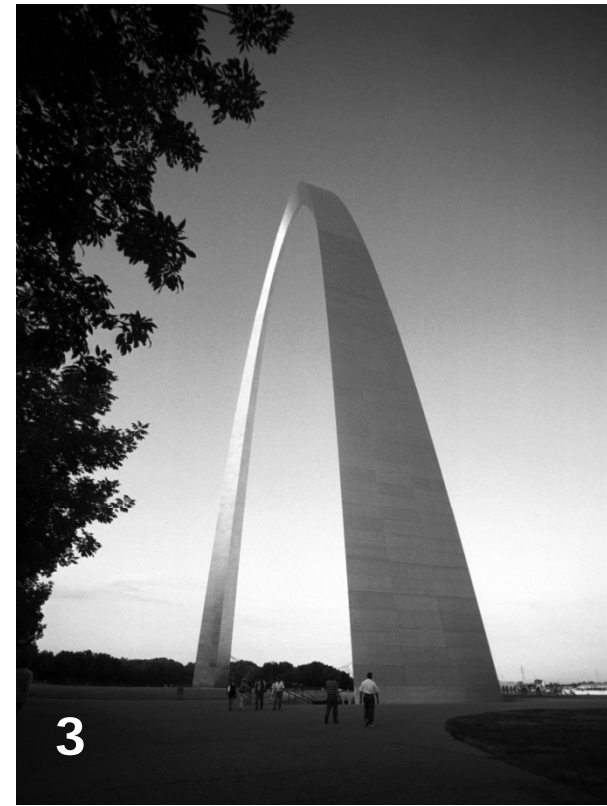

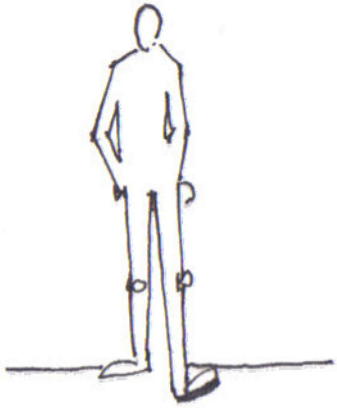

### Assignment:

Draw a scale figure, similar to the one shown above, next to each of the cubes.

For Cube 1: draw the scale figure so the cube could represent a house.

For Cube 2: draw the scale figure so the cube could represent a bench.

For Cube 3: draw the scale figure so the cube could represent a birthday present.

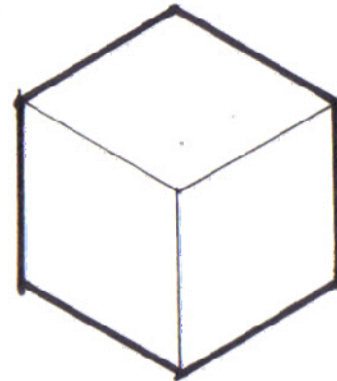
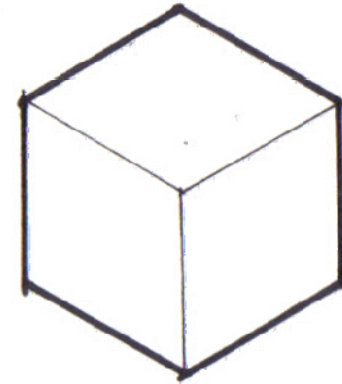
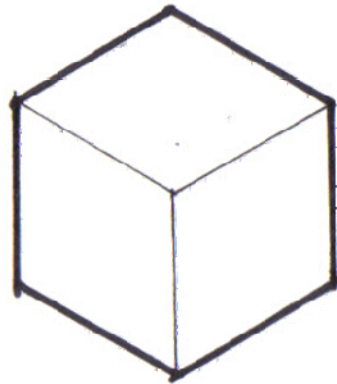

Sketching is a very important tool for architects. By sketching out an idea the architect can better communicate an idea to a client. Here is an example of a sketch by an architecture student, as well as an image of what they sketched.

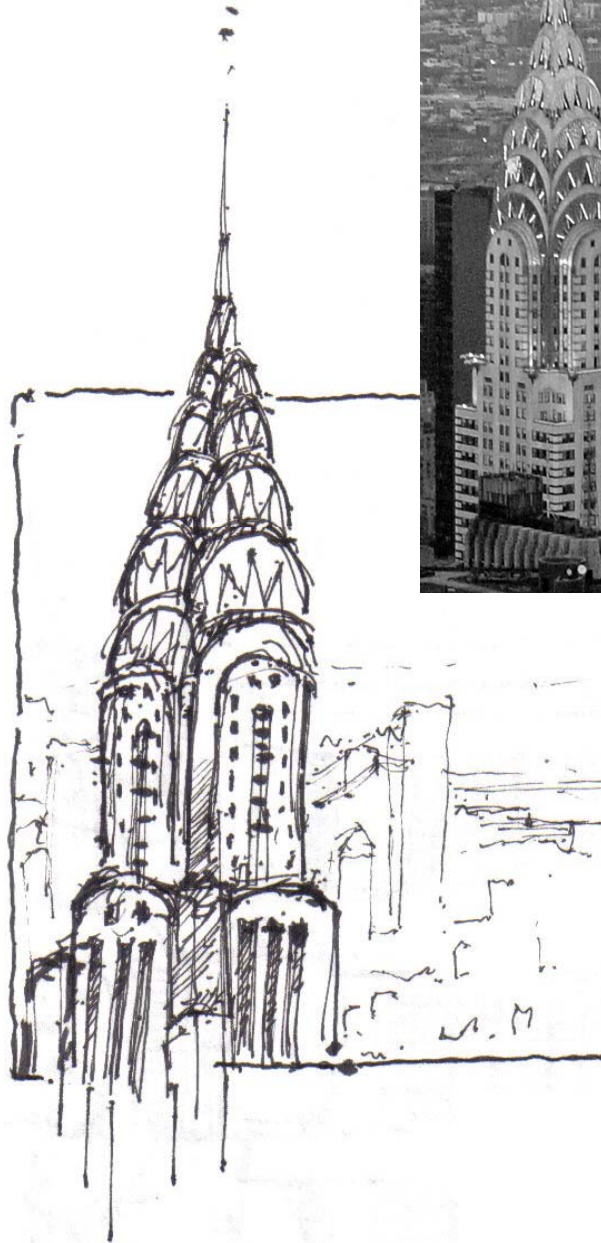

#### Assignment:

In the space provided to the far right try to sketch the same image looking at the photo and sketch. Remember to not worry about erasing.

Sketch by David Brown  
2003

Assignment:

Using this page, practice sketching [try sketching your building]. Remember your sketch is not supposed to be perfect.

Building of the Week:

The Arc de Triomphe was built in Paris, France in 1806. It was designed by Jean Chalgrin. It sits at the intersection of twelve streets called the Champs-Elysees. Pay particular attention to the little dots on the top of the Arc', those little dots are people.



## LESSON 5

Architecture is created from basic geometric shapes. In this lesson you will learn to identify those forms which compose the elevation of a building. When studying the elevation of a building, you are able to see different building materials, the elements which make up the building (windows, doors, etc) and the basic geometric shapes that form that building. You will be given the chance to compose your own elevation for *YOUR* building.

**Geometry:** the study of shapes (2D) and objects (3D).

**Elevation:** a drawing which shows any side of a building viewed as a two dimensional surface

**Two-dimensional:** having only two dimensions such as length and height. Not showing any depth.



Sir Christopher Wren, a famous British architect, designed many churches, cathedrals, chapels, and libraries. His works became famous after the Great Fire of London in 1666. Wren used basic geometric shapes to compose simple and elegant elevations of these buildings.

Wren claimed that the basic ideas of architecture are beauty, firmness and convenience. Beauty is harmony of objects, bringing pleasure to the eye. Beauty is in nature, which is rational, geometric, uniform, and proportional. Firmness is the state or quality of being solidly constructed. Convenience is something of value or use.

#### Assignment:

As a class, list and draw as many geometric shapes on the board as possible. Then using a marker trace over the geometric shapes you see in the elevations to the right.



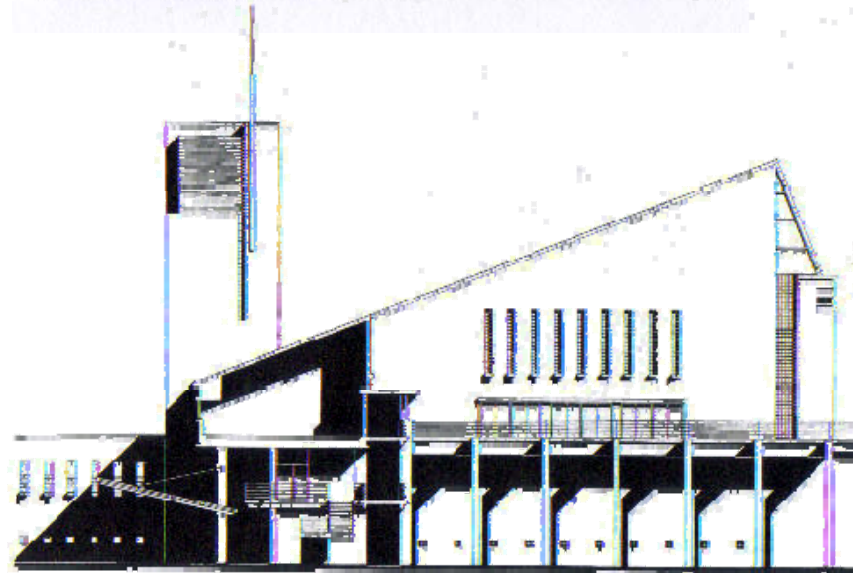
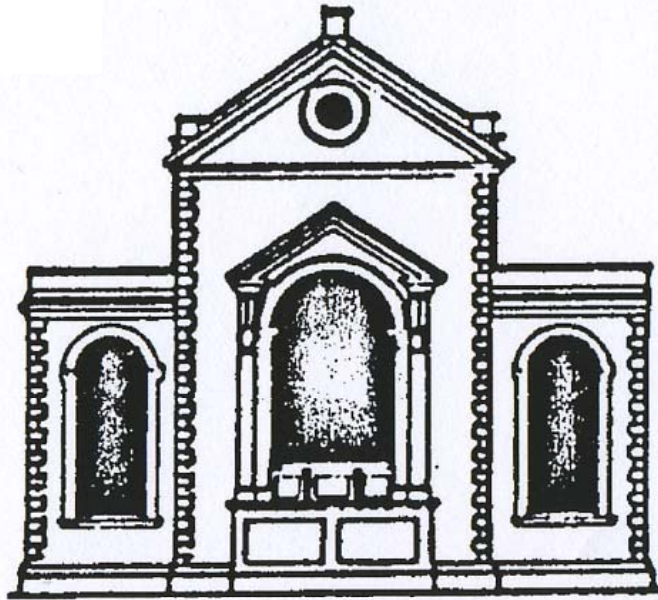

Geometry List: Elevations:



Drawing: Singapore American School, Singapore  
Medium: Ink on Mylar, 36" x 24" (91 x 61.4 cm)  
Courtesy of Perkins & Will Architects

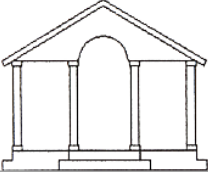
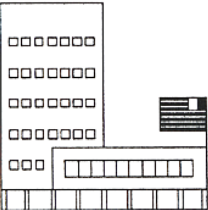
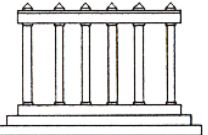
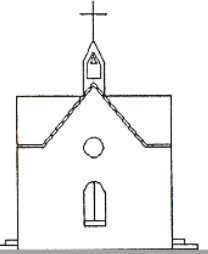

Architects and engineers use many different shapes when they design a building. These shapes give the building a special look. Each of the buildings on this page has several shapes.

BUILDING	 square	 rectangle	 triangle	 circle	 semi-circle	other shapes
						
						
						
						

**Assignment:**

Count each shape that you see and write the number in the box under that shape.

**Assignment:**

Use this page to compose your elevation. Use the shapes on the next two pages to do this. First lay the shapes down and move them around until you are happy with your elevation, then glue the pieces down.

## Assignment:

By cutting and pasting the shapes provided, design at least one elevation for your building. What do you want your elevation to say about your specific building? Should it be symmetrical? Low and horizontal? Tall, wide, solid, open with lots of glass, etc?

When you are done, go back in your free time and add renderings of the building materials that you would use to construct your building. Add people, trees, cars or anything else to your elevation(s)!

Have fun using your creative and visual thinking skills!

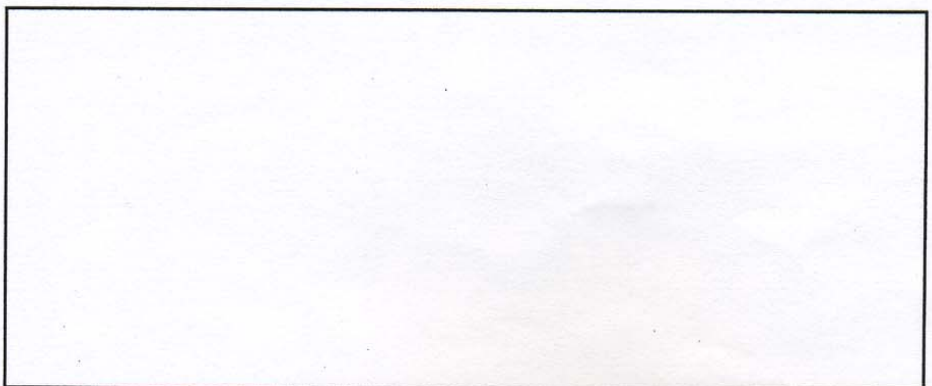
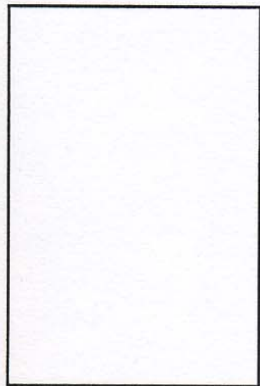
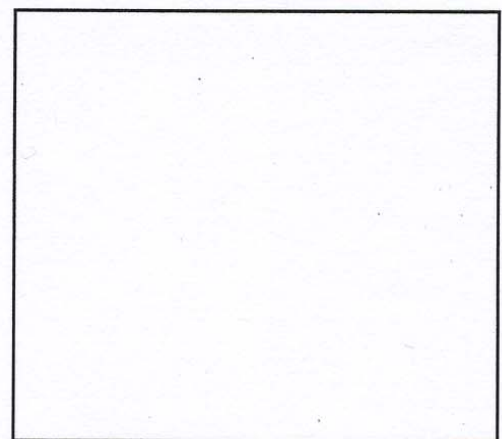
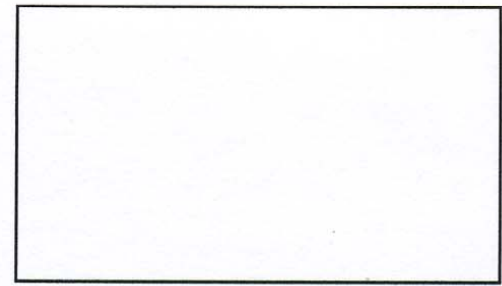
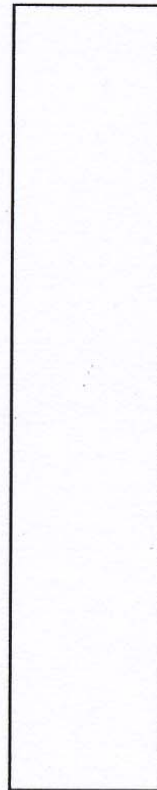
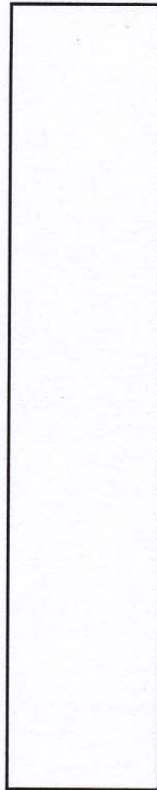
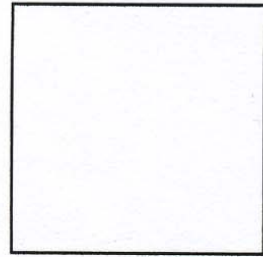

**Assignment:**

By cutting and pasting the shapes provided, design at least one elevation for your building. What do you want your elevation to say about your specific building? Should it be symmetrical? Low and horizontal? Tall, wide, solid, open with lots of glass, etc?

When you are done, go back in your free time and add renderings of the building materials that you would use to construct your building. Add people, trees, cars or anything else to your elevation(s)!

Have fun using your creative and visual thinking skills!

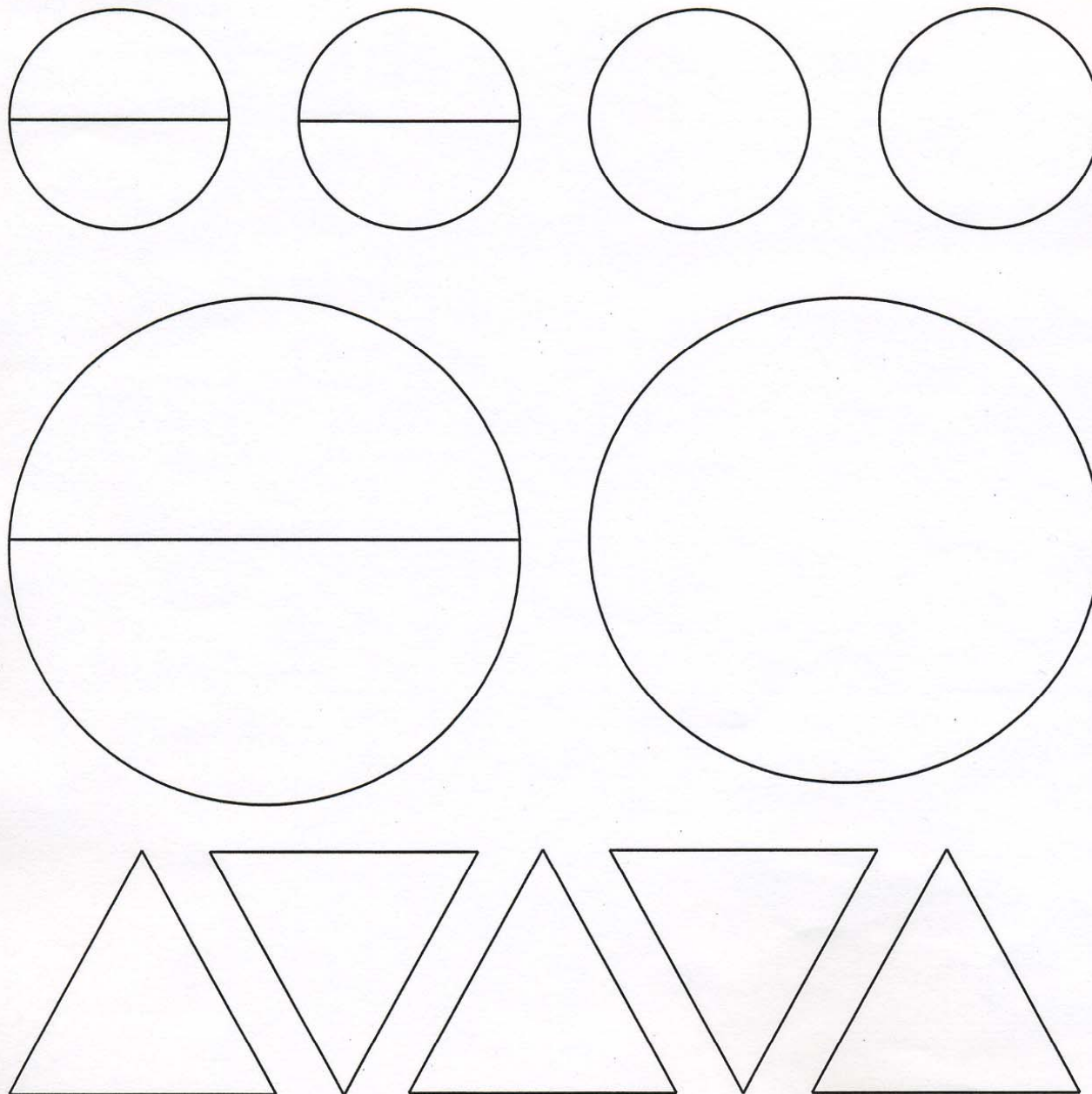

Building of the Week:

San Miniato al Monte was a monastery built in Florence, Italy from 1018 to 1207. Notice the many shapes that are used in the composition of this elevation. This is a very unique Florentine Romanesque church that influenced architects such as Leon Battista Alberti during the Italian Renaissance.



## LESSON 6

Today's lesson will teach you how to graphically explain the layout of a room in a drawing known as a floor plan. Similar to the elevations we studied last week, floor plans are two-dimensional drawings that use simple geometrical diagrams to explain rooms.

**Floor Plan:** a drawing used to show the interior spaces of the building and how they relate to each other.

**Symbol:** a graphic representation of a real life object in a drawing.

**Two-dimensional:** having only two dimensions such as length and height. Not showing any depth.



A floor plan is an important communication tool between architects and their clients. The floor plans shown on this page are from the Cathedral at Reims, France and a Greek temple called the Parthenon built in the 5<sup>th</sup> century.

The floor plan for a building can be very simple or very complex depending upon the number of functions in a space and the way the architect wants it. Can you find the walls, columns, and stairs in these plans? What do you think the X's in the Cathedral's plan represent?



PICTORIAL DRAWING

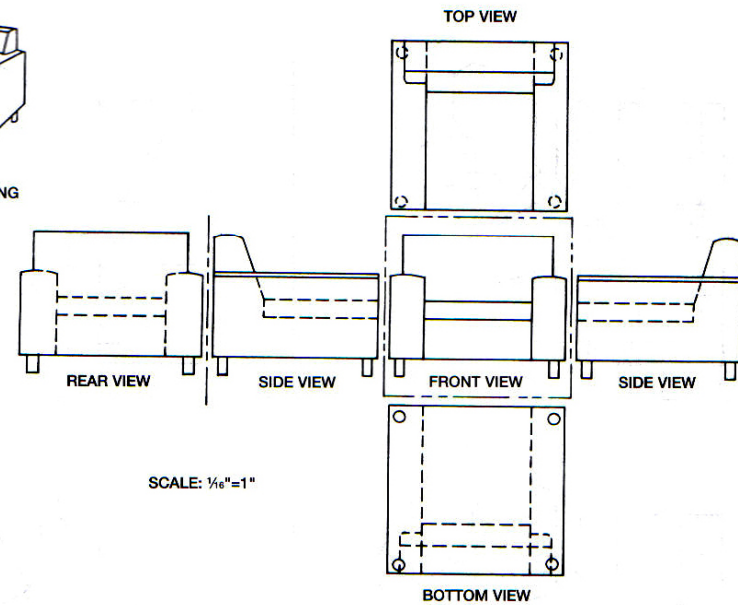

SCALE: 1/16"=1"

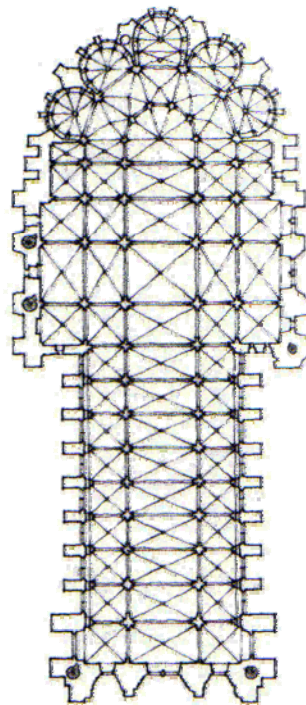

Cathedral at Reims, 1211-1290

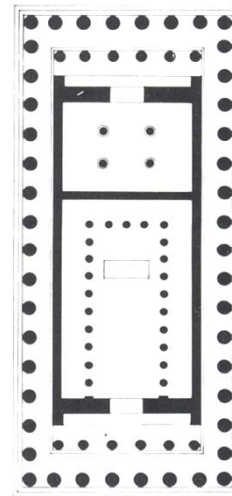

The Parthenon

Cathedral and Chair Drawings by  
Francis Ching  
Parthenon Plan from Charbonneaux-  
Martin-Villard

Floor plans show more than just walls and room sizes. A floor plan also shows the location of windows, doors and sometimes furniture.

Symbols are commonly used by architects to communicate his or her ideas. Some common symbols used are those for doors, windows, furniture and walls.

**Assignment:**

Try to identify what the symbols shown in the space to the right represent and then recreate the symbols in the space provided.

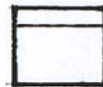
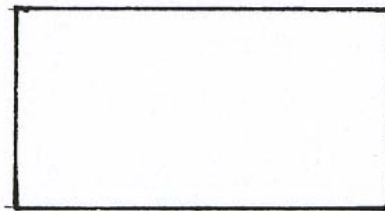
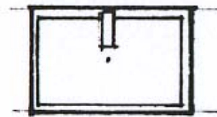
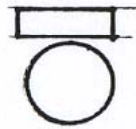
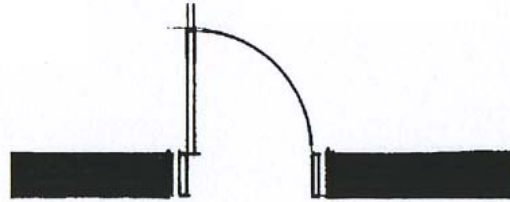
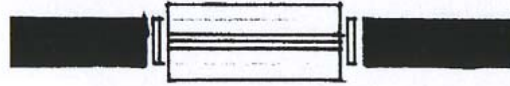



**Assignment:**

Now that you have practiced drawing some of the different symbols that an architect would use, locate as many symbols as possible on this floor plan of a house and write their names on the plan.

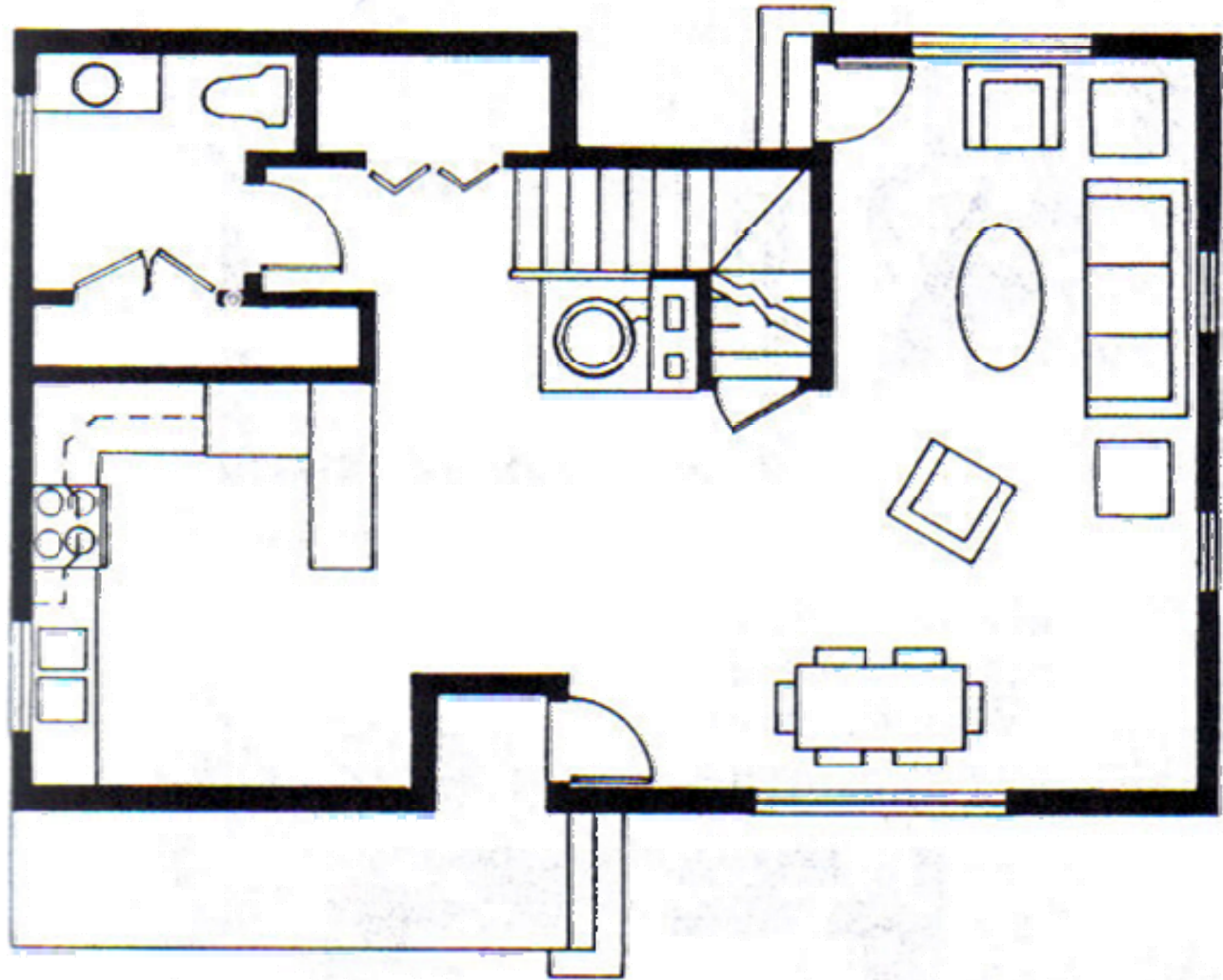

**Assignment:**

Draw the plan of your classroom in the space provided while your ASTEK leaders are drawing it on the board. Include the walls, windows, doors, desks, and any other furniture that is in your classroom.

**Assignment:**

Now try to draw the floor plan for the building you are designing for your class' city. How many different rooms do you think your building needs?

### Building of the Week:

The Glass House was designed by Philip Johnson in 1949, in New Canaan, Connecticut. Wanting to create a very open [transparent] floor plan, Johnson replaced nearly all the walls with glass. It has been described as “the most beautiful, yet least functional house ever built.”

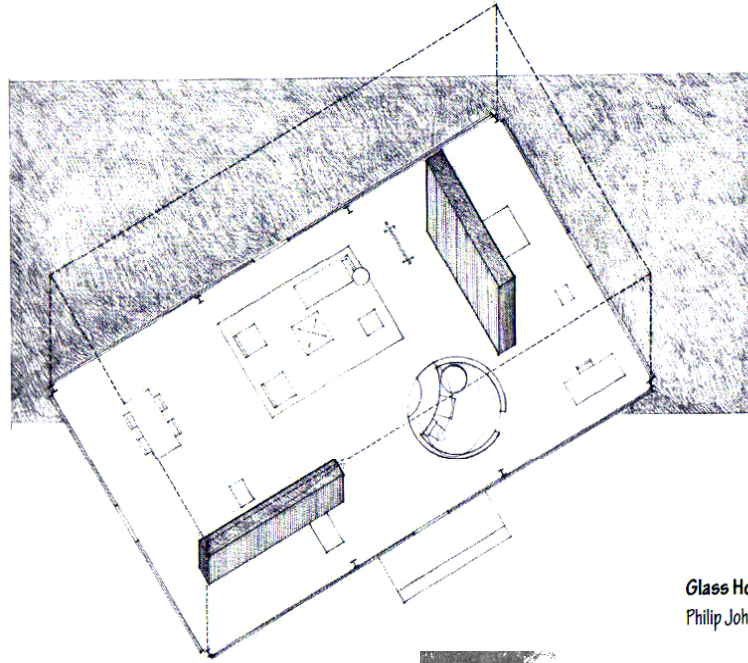

Glass House, New Canaan, Connecticut, 1949,  
Philip Johnson



Drawing by Francis Ching

## LESSON 7

Today's lesson will teach you the importance of structure and how structure allows a building to actually stand up on its own.

**Load:** the weight that a structure holds or the stresses that are put on it.

**Deflection:** the distance the beam sags or bends from the amount of load applied.

**Support:** a structural element used to carry the load.

**Span:** the amount of space between two supports.



Most buildings are built of vertical supports known as POSTS or COLUMNS and horizontal supports called BEAMS or LINTELS. The distance between the two supports is called the SPAN.

When weight or LOAD is added to the center of a beam it will sag. This sag is called DEFLECTION.

We can reduce deflection by moving supports closer together or putting extra supports.

We can test this with a ruler or yardstick. By holding the yardstick at each end and pushing down in the middle the yardstick will deflect. If we move our hands closer together the yardstick gets harder to bend. If you turn the yardstick so the load is applied to the skinny edge it is even harder to bend. Why do you think this happens?

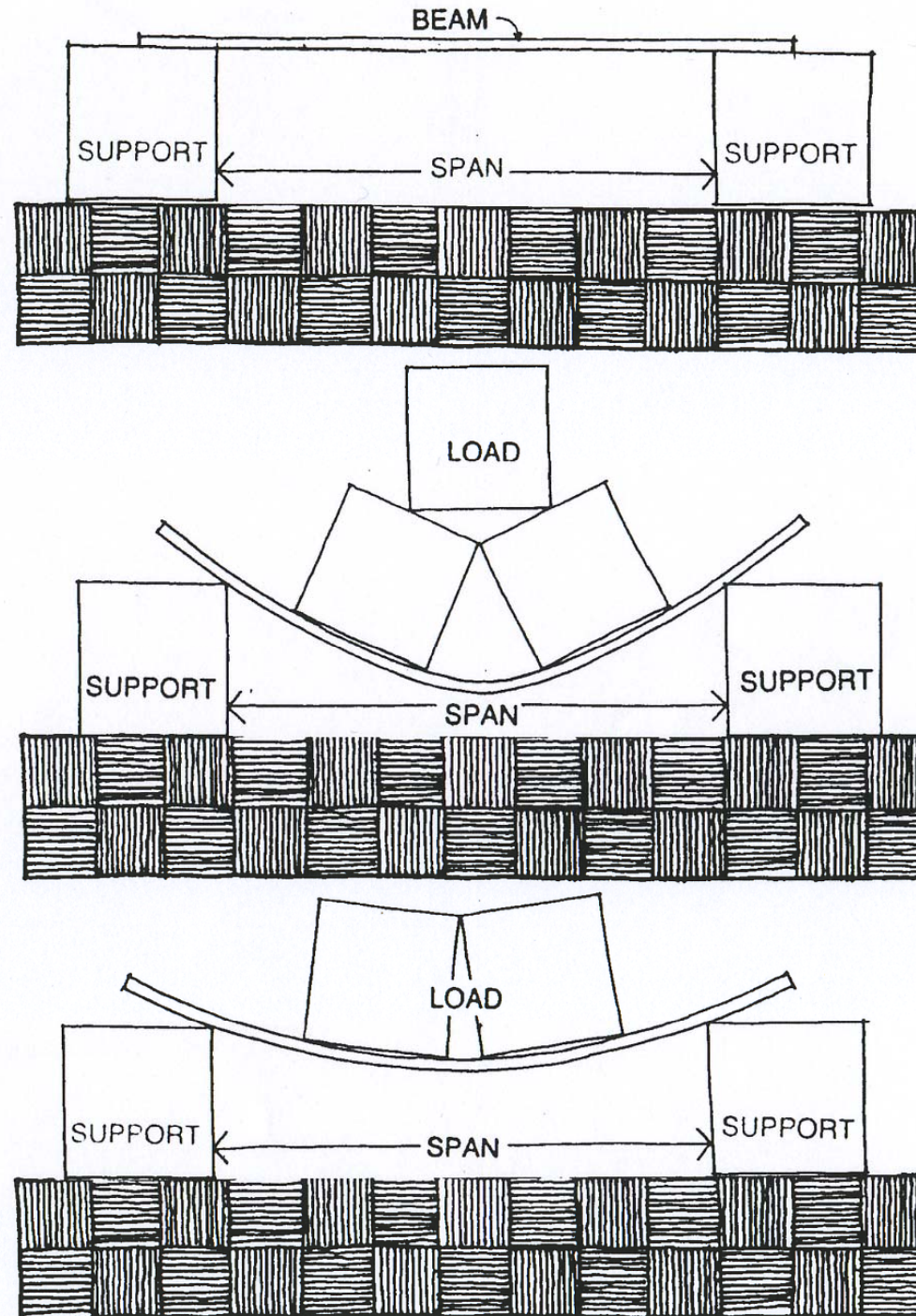



A POST and BEAM system is the simplest form of the trabeated system. The distance between the posts is called the SPAN. By placing several posts and beams side by side we can create a colonnade.

An ARCH is constructed of wedge shaped blocks called voussoirs (voo swär') and a special wedge called a keystone. The keystone is the most important piece to the arch, it is the top voussoir and without it the arch would fall down. An arch can be placed on the top of columns similar to a beam. A series of arches side by side is called an arcade.

A BARREL VAULT is a series of arches placed back to back. A barrel vault is considered a special kind of vault. Many of these vaults create an outward force, called thrust, on the walls that support them. To stop this from happening a BUTTRESS is used to support the post or wall.

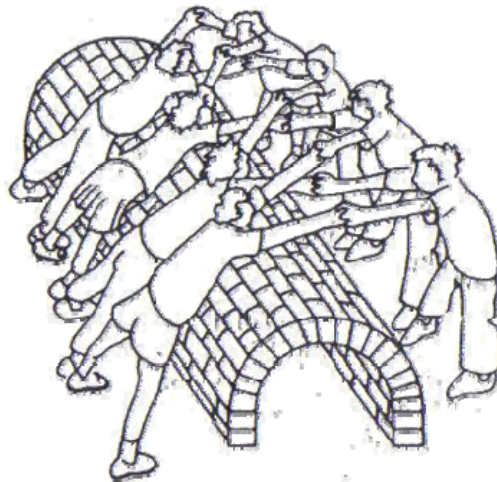
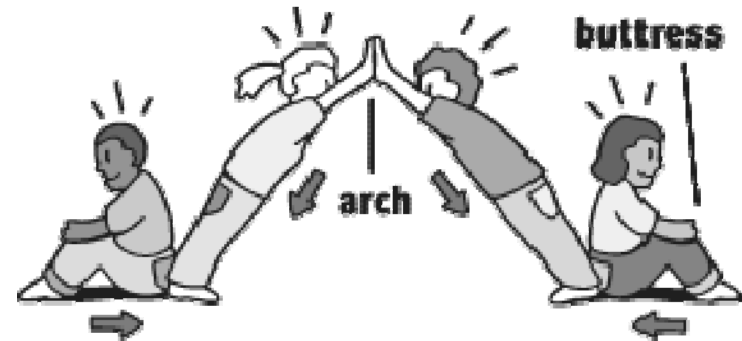
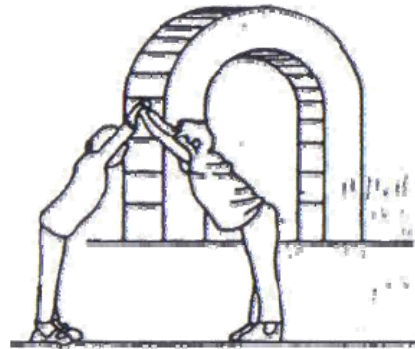
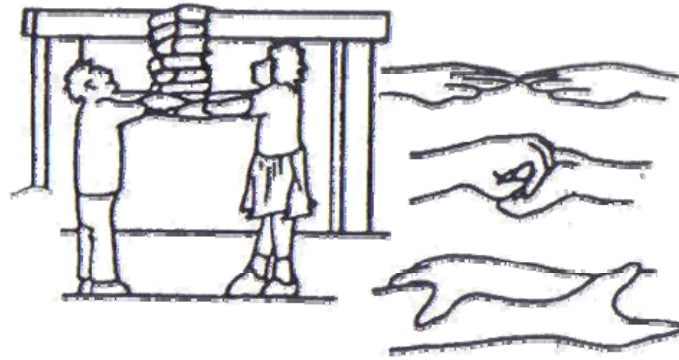

A **DOME** is made when you take an arch and spin it so that it looks like half of a ball. Like the barrel vault the dome creates a large amount of thrust and requires the use of a **BUTTRESS** to counteract the thrust.

A **BUTTRESS** is a thick wall that helps support the post that the arch or vault rests on.

A **FLYING BUTTRESS** is a thick wall that has part of the wall removed to allow more room around the base of the buttress, while still supporting the post that the arch or vault rests on. These were popular to use in the Gothic architectural period.

A **TRUSS** is a continuous series of triangles made from lighter weight materials. Due to its design it will support more weight than the beam it replaces. Trusses take the place of a beam in a post and beam system.

A **CANTILEVER** is a projecting structure supported at only one end, such as a shelf bracket or diving board.

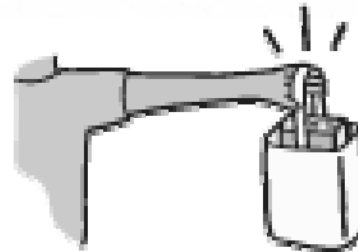
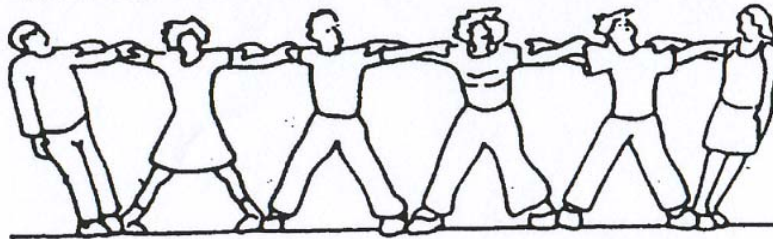
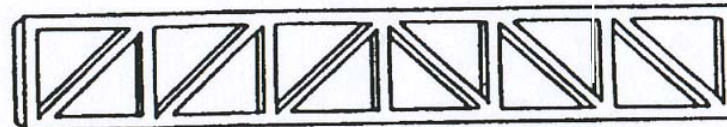

**· flying buttress**

An inclined bar of masonry carried on a segmental arch and transmitting an outward and downward thrust from a roof or vault to a solid buttress that through its mass transforms the thrust into a vertical one. Also called **arc-boutant**.

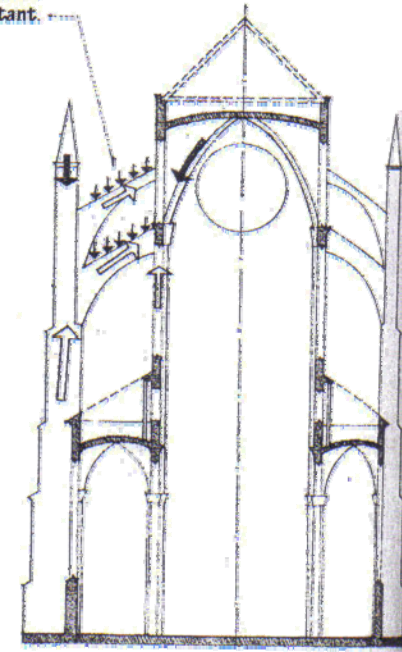

## Assignment

Can you identify which structural elements are being used in the examples to the right?

- 1.
- 2.
- 3.
- 4.
- 5.
- 6.
- 7.
- 8.

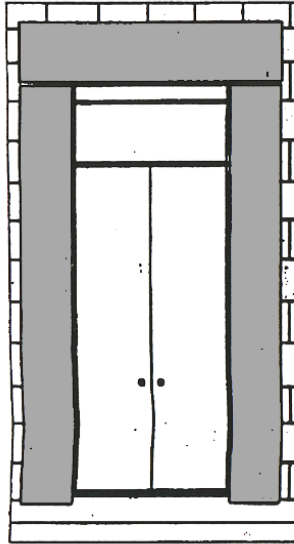

1

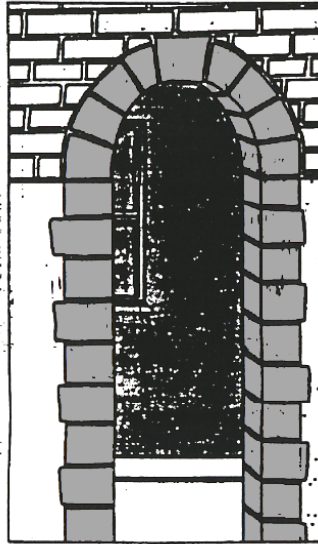

2



3

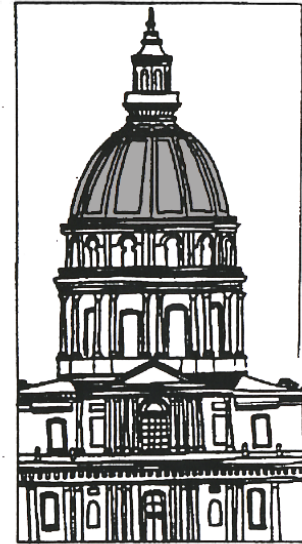

4

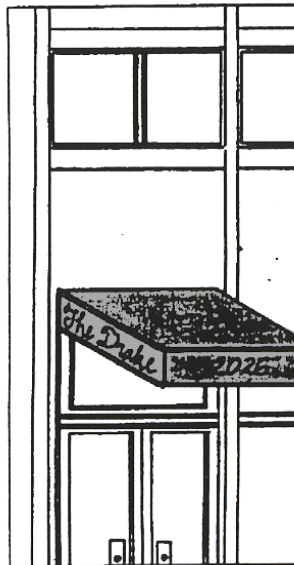

5

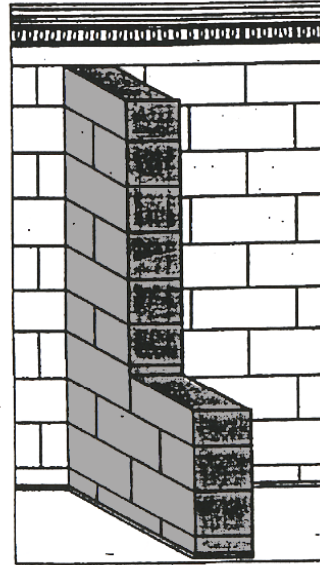

6



7

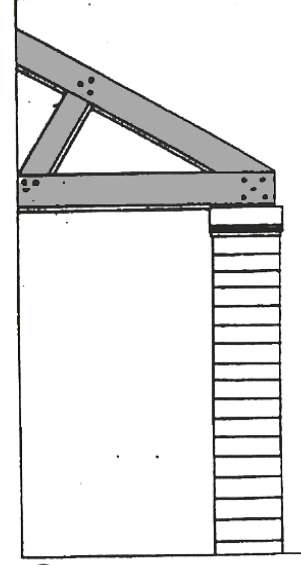

8



### Building of the Week:

The Pompidou Center was built in Paris, France in 1977. It was designed by Renzo Piano and Richard Rogers. Built as a modern art museum, the Pompidou Center has all of its structure and services, such as plumbing and escalators, on the exterior so that the maximum amount of space is left open on the interior.

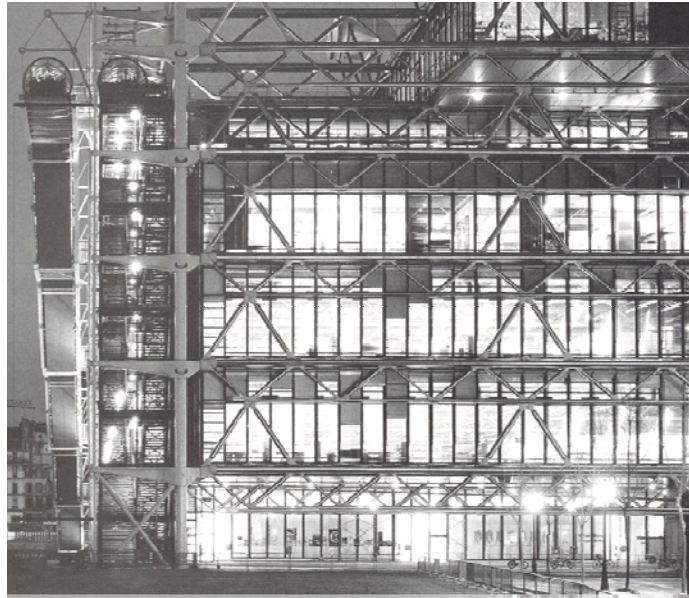

## LESSON 8

Now we will begin to construct your building that you have sketched and thought about for several weeks now.

**Model:** a small-scale representation of a life-size object.

**Entourage:** (än'too räzh') surroundings and environment that help a drawing or model become understandable.

**Construction:** building or forming something by fitting parts together.

On this page are some examples of different study models done by college architecture students.

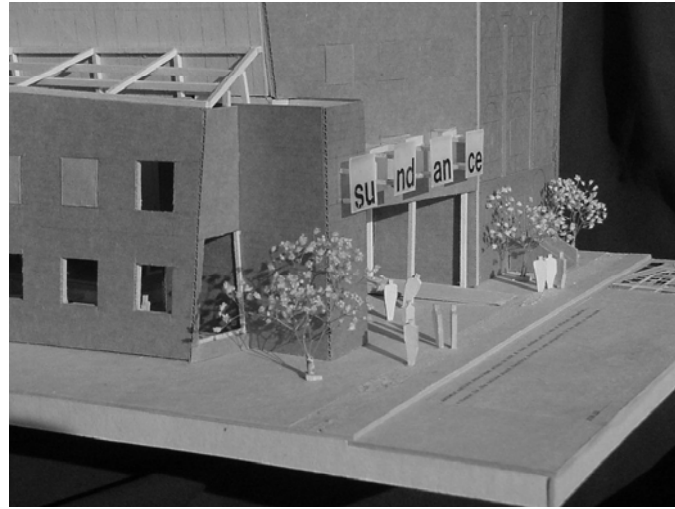



Building of the Week:

Here are several pictures of construction at Boone-Pickens Stadium at Oklahoma State University.



BEGIN BUILDING

## LESSON 8

Now we will FINISH constructing your building that you started last week.

**Model:** a small-scale representation of a life-size object.

**Entourage:** (än'too räzh') surroundings and environment that help a drawing or model become understandable.

**Construction:** building or forming something by fitting parts together.

On this page are some examples of models completed by other fifth grade students.

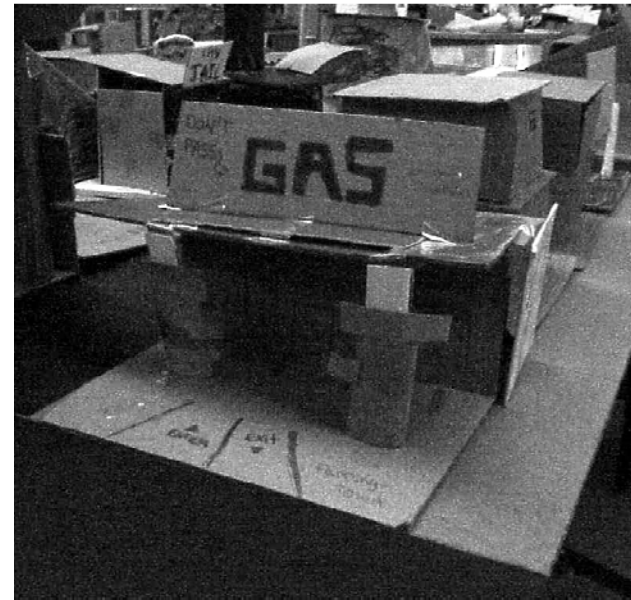
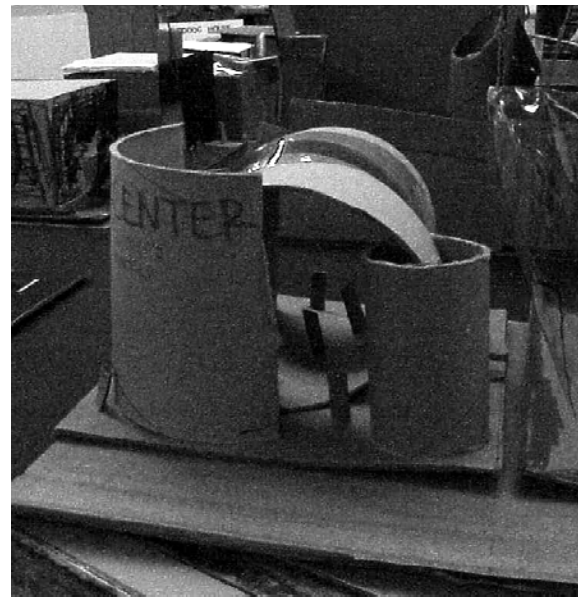
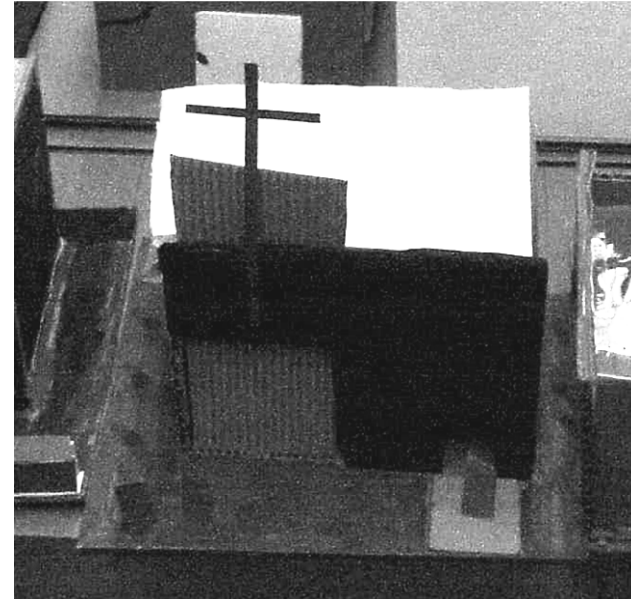

### Crossword Word Bank

Arch  
 Architect  
 Bay  
 Beam  
 Blueprint  
 Bridge  
 Column  
 Contractor  
 Corinthian  
 Dome  
 Ell  
 Engineers  
 Keystone  
 Landmarks  
 Lumber  
 Nature  
 On  
 Post  
 Roof  
 Sewer  
 Street  
 Structures  
 Tar  
 Tower  
 Town  
 Truss

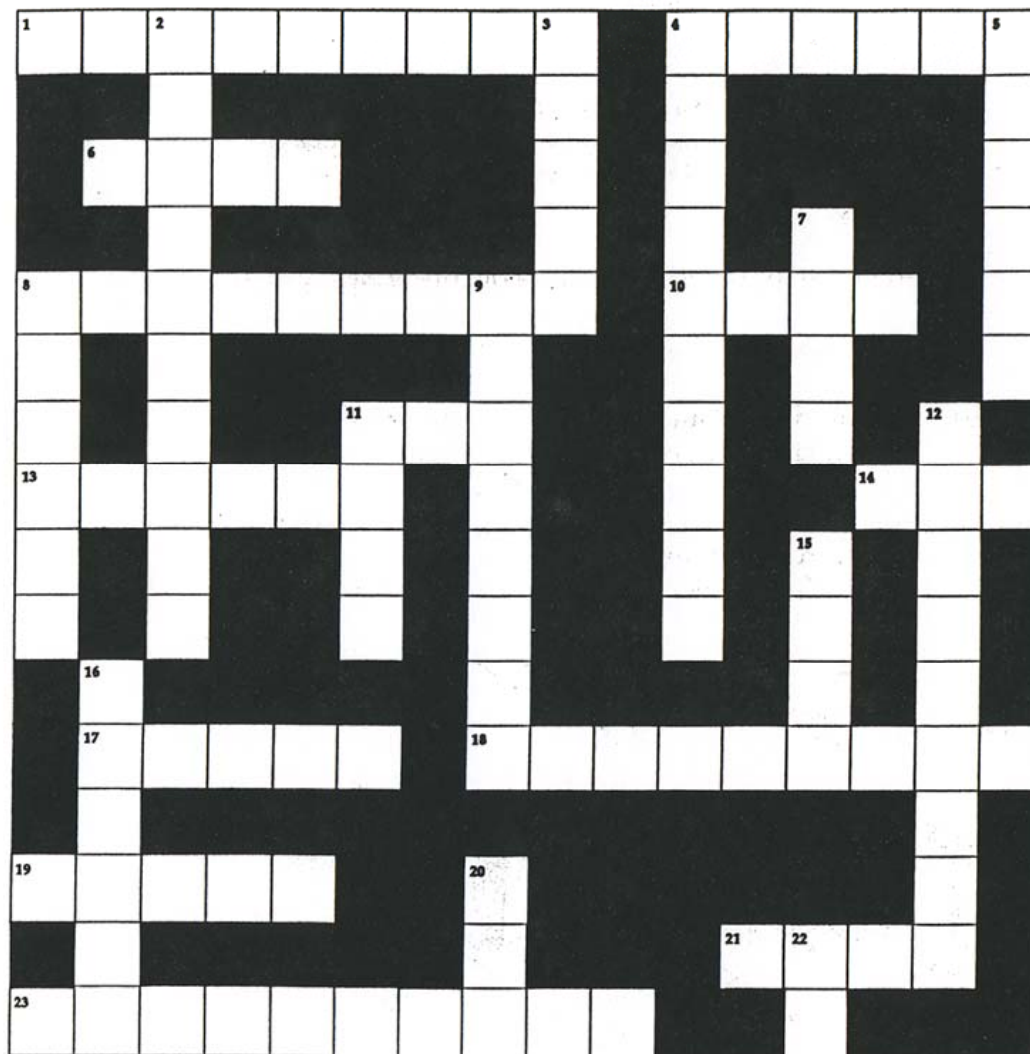

#### ACROSS

- 1) Someone who designs buildings
- 4) Slender, upright structure
- 6) An upside down u-shaped structure
- 8) Structures that remind you of your community
- 10) The cover on top of a house
- 11) Type of window
- 13) Structure built across a river
- 14) Some additions to a building are \_\_-shaped
- 17) A tall structure, as in "T.V. \_\_\_\_\_"
- 18) People who design bridges and other structures
- 19) Underground structure to carry water
- 21) A \_\_\_\_\_ helps to support a beam
- 23) Buildings, towers and bridges are all examples of \_\_\_\_\_

#### DOWN

- 2) \_\_\_\_\_ Hall, home to the Kansas City Museum
- 3) Framework that holds up a roof or bridge
- 4) The company that builds a building
- 5) Building materials like stone and wood are made by Mother \_\_\_\_\_
- 7) A small city is usually called a \_\_\_\_\_
- 8) Some houses are made of wood from the \_\_\_\_\_ yard
- 9) This keeps the other stones in an arch in place
- 11) A long piece of wood, metal or stone used to hold a structure up
- 12) Contractors use this as a guide when they build
- 15) Rounded roof
- 16) Cars travel on this
- 20) Streets are paved with this
- 22) "\_\_\_\_ Any Corner"

We would like to invite you to come see all of the models constructed by the ASTEK classes this semester at the Open House. Your models will be on display in the architecture gallery which is open Monday through Friday, from 8:00am until 5:00pm.

Thank you for participating in this program. We hope that you enjoyed it and learned a little bit more about the built environment around you.

Architecture Building  
Student Gallery located  
directly south of Boone  
Pickens Stadium,  
Oklahoma State  
University Campus.



GALLERY SHOW

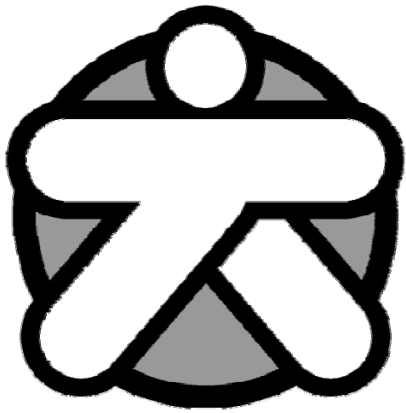

The ASTEK book is a publication issued by the students of the Oklahoma State University School of Architecture in Stillwater, Oklahoma. Design, layout and editing by Charisse Bennett and Sarah Holstedt, January 2004. The ASTEK logo was designed by Dustin Siegrist, December 2003. The ASTEK program and the contents of this book are not copyrighted, but should you take credit for our ideas we will get very mad.

Printed January 2010.