



ProboStat™ Manual

Version 8
Update: 16 October 2018

Copying allowed for internal use within organisation of buyer of the product.

Other reproduction prohibited without permission from NORECS AS.

NORECS AS takes on no responsibilities for the consequences of contents, missing parts, or errors in this manual.

NORECS AS
Gaustadalleen 21
NO-0349 Oslo, Norway

Tel.: +47-45916188
Email: post@norecs.com
Internet: www.norecs.com

NORECS

1	INTRODUCTION.....	1-7
1.1	ABOUT THIS MANUAL.....	1-7
1.2	SERIAL NUMBERS AND VERSIONS.....	1-7
1.3	TRANSPORTATION AND WARRANTIES.....	1-8
1.4	RIGHTS.....	1-8
2	SAFETY FIRST.....	2-1
3	UNPACKING.....	3-1
3.1	ALUMINIUM CASES.....	3-1
3.2	CARDBOARD BOXES.....	3-1
4	CONTENTS, CONSTRUCTION, CONFIGURATIONS AND ASSEMBLY.....	4-1
4.1	STAND SET (IF SUPPLIED).....	4-1
4.2	BASE UNIT; CONSTRUCTION, FUNCTIONS, AND ACCESSORIES.....	4-2
4.2.1	<i>Base unit.....</i>	4-2
4.2.2	<i>Water cooling.....</i>	4-3
4.2.3	<i>Connector box and cooling water ring; change angle of the fixation bar.....</i>	4-4
4.2.4	<i>Gas connects.....</i>	4-5
4.2.5	<i>How to connect a 1/8" tube to a Swagelok stem or other tube fitting.....</i>	4-6
4.2.6	<i>Electrical feedthroughs.....</i>	4-7
4.2.7	<i>Sockets and switches on the connector box.....</i>	4-8
4.2.8	<i>Wiring schemes.....</i>	4-10
4.3	ENCLOSING (OUTER) TUBES.....	4-12
4.4	SAMPLE SUPPORT TUBES.....	4-12
4.5	GAS SUPPLY TUBES.....	4-13
4.6	SPRING LOAD ASSEMBLIES.....	4-14
4.6.1	<i>Alumina triangular top plate spring load assembly.....</i>	4-14
4.6.2	<i>Two-rod van der Pauw spring load assembly.....</i>	4-14
4.6.3	<i>General concerns regarding spring loads.....</i>	4-15
4.7	THERMOCOUPLES AND ELECTRODE CONTACTS.....	4-15
4.7.1	<i>Thermocouples.....</i>	4-17
4.7.2	<i>Electrode contacts.....</i>	4-18
4.8	ACCESSORIES (SOME OPTIONAL).....	4-19
5	MAINTENANCE.....	5-1
5.1	CLEANING.....	5-1
5.2	PLATINUM PARTS.....	5-1
5.3	O-RINGS.....	5-2
5.4	LUBRICATION.....	5-2
5.5	STORAGE.....	5-2
6	SPECIFICATIONS.....	6-1
6.1	MATERIALS.....	6-1
6.2	MAXIMUM TEMPERATURES.....	6-1
6.2.1	<i>Hot zone parts.....</i>	6-1
6.2.2	<i>Cell interiors in the cold part.....</i>	6-1
6.2.3	<i>Entire ProboStat unit.....</i>	6-1
6.3	PRESSURES, VACUUM, LEAKAGE RATES, ATMOSPHERE PURITY.....	6-1
6.4	ELECTRICAL SPECIFICATIONS.....	6-2
6.4.1	<i>Open circuit parasitic admittances.....</i>	6-2
6.4.2	<i>Short circuit impedance.....</i>	6-2
6.4.3	<i>Maximum voltages.....</i>	6-3
6.4.4	<i>Maximum currents.....</i>	6-3
7	CHECKS BEFORE MEASUREMENTS.....	7-1
7.1	ELECTRICAL WIRES.....	7-1
7.2	THERMOCOUPLE OPERATION, CALIBRATION, AND TEMPERATURE PROFILES.....	7-1
7.2.1	<i>General considerations and preparations.....</i>	7-1
7.2.2	<i>Check of proper temperature control.....</i>	7-2
7.2.3	<i>Centre of the hot zone.....</i>	7-3
7.2.4	<i>Temperature profile.....</i>	7-3
7.3	GAS TIGHTNESS.....	7-4
7.3.1	<i>Checking gas tightness using slight overpressure.....</i>	7-4
7.3.2	<i>Checking gas tightness using vacuum.....</i>	7-4
7.3.3	<i>Sources of leakage.....</i>	7-5

8	METHODS AND MEASUREMENTS.....	8-1
8.1	TEMPERATURE MEASUREMENTS.....	8-1
8.2	CONDUCTIVITY AND IMPEDANCE MEASUREMENTS.....	8-2
8.2.1	General.....	8-2
8.2.2	2-point impedance spectroscopy and conductivity measurements on disk sample.....	8-2
8.2.3	2-point conductivity measurements on disk sample with surface guard.....	8-8
8.2.4	4-point conductivity measurements on bar sample.....	8-9
8.2.5	Van der Pauw 4-point conductivity measurements.....	8-11
8.2.6	Electrode impedance studies on disk sample with ring reference electrode.....	8-14
8.2.7	Voltammetry studies on disk sample with ring reference electrode.....	8-15
8.2.8	Asymmetrical sealed cell with reference electrode.....	8-17
8.3	EMF TRANSPORT NUMBER MEASUREMENTS.....	8-19
8.4	FUEL CELLS AND ELECTROLYSERS (ELECTROCHEMICAL REACTORS).....	8-23
8.4.1	General.....	8-23
8.4.2	Disk samples (button cells).....	8-23
8.4.3	Tubular metal-supported SOFC and SOEC.....	8-25
8.4.4	Connections for fuel cell and electrolyser.....	8-27
8.4.5	SOFC and SOEC tests.....	8-28
8.5	SEEBECK COEFFICIENT (THERMOELECTRIC POWER) MEASUREMENTS.....	8-30
8.5.1	Seebeck coefficients only.....	8-30
8.5.2	Combined Seebeck coefficients and conductivity measurements.....	8-36
8.6	PERMEABILITY MEASUREMENTS.....	8-38
8.6.1	Disk membranes.....	8-38
8.6.2	Tubular membranes and catalytic membrane reactors (CMRs).....	8-39
8.6.3	Measurements and interpretation.....	8-40
9	SPECIAL EXPERIMENTS AND CONDITIONS.....	9-1
9.1	REDUCED NOISE AND CROSSOVER SIGNALS.....	9-1
9.1.1	High frequency noise.....	9-1
9.1.2	Hum noise.....	9-2
9.1.3	DC stability and low frequency noise.....	9-3
9.2	VERY HIGH TEMPERATURES.....	9-3
9.3	OVER-ATMOSPHERIC PRESSURES.....	9-3
9.4	WET GASES WITH DEW-POINTS ABOVE ROOM TEMPERATURE.....	9-4
9.5	TRANSIENT MEASUREMENTS.....	9-4
9.6	CONTROL AND MONITORING OF ATMOSPHERE COMPOSITION.....	9-6
9.6.1	Oxygen activity control and monitoring.....	9-6
9.6.2	Integration of sensors in a ProboStat.....	9-6
9.7	MEASURING LIQUIDS.....	9-8
9.8	HIGH VOLTAGE VERSION OF PROBOSTAT.....	9-8
10	AUXILIARY UNITS.....	10-9
10.1	TEMPERATURE CONTROL SYSTEM.....	10-9
10.1.1	Furnace.....	10-9
10.1.2	Power supply.....	10-9
10.2	WATER COOLING SYSTEM.....	10-9
10.3	GAS MIXER AND GAS HANDLING.....	10-10
10.4	ELECTRICAL CHARACTERISATION INSTRUMENTS.....	10-11
10.5	SOFTWARE.....	10-11
10.5.1	Software for running measurements.....	10-11
10.5.2	Controlling temperature.....	10-11
10.5.3	Analysing impedance spectra.....	10-11
10.5.4	Software for gas mixing.....	10-11
10.5.5	Analysing conductivity, Seebeck coefficients, etc.....	10-12
11	MALFUNCTIONS AND REPAIRS - TROUBLESHOOTING.....	11-1
11.1	COOLING WATER LEAKAGE.....	11-1
11.2	GAS LEAKAGE.....	11-1
11.3	BREAKAGE IN ELECTRICAL LEADS.....	11-2
11.4	BROKEN FEEDTHROUGH (MALE) ON THE BASE UNIT.....	11-2
11.5	BURNING OF PARTS ON THE BASE UNIT.....	11-2
11.6	MECHANICAL PARTS STUCK.....	11-2
11.7	SEEMINGLY ERRATIC, RANDOM, OR NOISY MEASUREMENTS.....	11-3

12	INSTRUCTIONS FOR FABRICATION OF PARTS AND SAMPLES	12-1
12.1	INSTRUCTIONS FOR FABRICATION OF CERAMIC PARTS.....	12-1
12.1.1	<i>Enclosing (outer) tubes</i>	<i>12-1</i>
12.1.2	<i>Sample support tube assemblies for disk samples</i>	<i>12-2</i>
12.1.3	<i>Sample support tube assembly for bar samples.....</i>	<i>12-2</i>
12.1.4	<i>Inner gas tubes</i>	<i>12-3</i>
12.1.5	<i>Outer straight gas tubes</i>	<i>12-4</i>
12.1.6	<i>Outer bent gas tubes.....</i>	<i>12-5</i>
12.1.7	<i>Outer bent gas tube for wide samples (24 mm support).....</i>	<i>12-5</i>
12.2	INSTRUCTIONS FOR FABRICATION OF SPRING LOAD ASSEMBLIES	12-5
12.2.1	<i>Spring load assembly, standard.....</i>	<i>12-5</i>
12.2.2	<i>Spring load assembly for van der Pauw setup</i>	<i>12-7</i>
12.2.3	<i>Spring load assembly for wide samples.....</i>	<i>12-8</i>
12.2.4	<i>Spring load assemblies with Kanthal wire</i>	<i>12-9</i>
12.3	INSTRUCTIONS FOR FABRICATION OF THERMOCOUPLE ASSEMBLIES.....	12-10
12.3.1	<i>General.....</i>	<i>12-10</i>
12.3.2	<i>Thermocouple assembly for disk sample, top (TCT/D)</i>	<i>12-11</i>
12.3.3	<i>Thermocouple assembly for disk sample, inner (TCI/D).....</i>	<i>12-11</i>
12.3.4	<i>Thermocouple assembly for disk sample, control (TCC/D).....</i>	<i>12-11</i>
12.3.5	<i>Thermocouple assembly for bar sample, control (TCC/B).....</i>	<i>12-11</i>
12.3.6	<i>Thermocouple assembly for bar sample, bottom (TCB/B)</i>	<i>12-12</i>
12.3.7	<i>Thermocouple assembly for bar sample, top (TCT/B).....</i>	<i>12-12</i>
12.4	INSTRUCTIONS FOR FABRICATION OF ELECTRODE CONTACT ASSEMBLIES	12-12
12.4.2	<i>Electrode hand'contact assembly, outer, 2-wire (H2N#, # - diameter of Pt net disk)</i>	<i>12-13</i>
12.4.3	<i>Electrode hand'contact assembly, outer, 1-wire, HV-version (H1N10HV).....</i>	<i>12-14</i>
12.4.4	<i>Electrode hand'contact assembly, outer, 1-wire, top (H1TN10).....</i>	<i>12-14</i>
12.4.5	<i>Electrode hand'contact assembly, outer, 1-wire, bottom (H1BN10).....</i>	<i>12-15</i>
12.4.6	<i>Electrode contact assembly, inner, 2-wire (IN2).....</i>	<i>12-16</i>
12.4.7	<i>Electrode "hand" contact assembly, inner, 2-wire (INH2N12).....</i>	<i>12-17</i>
12.4.8	<i>Electrode contact assembly, general purpose, 2-wire (GP2)</i>	<i>12-17</i>
12.4.9	<i>Electrode contact assembly, general purpose, 1-wire (GP1)</i>	<i>12-18</i>
12.4.10	<i>Contact pair assembly, van der Pauw setup (VDP2).....</i>	<i>12-18</i>
12.4.11	<i>Guard rings (GR#, #=diameter of ring)</i>	<i>12-18</i>
12.4.12	<i>Guard rings for HV version cell (GR#HV, # - diameter of ring)</i>	<i>12-19</i>
12.4.13	<i>Electrode nets with 2 contacts (GP2N#, # - diameter of Pt net disk)</i>	<i>12-19</i>
12.5	GOLD GASKETS	12-19
13	SELECTED SCIENTIFIC THEMES IN MORE DETAIL	13-20
13.1	INTRODUCTION TO IMPEDANCE SPECTROSCOPY OF MATERIALS	13-20
13.1.1	<i>Alternating current and impedance</i>	<i>13-20</i>
13.1.2	<i>Passive electrical circuit elements and their characteristics.....</i>	<i>13-20</i>
13.1.3	<i>Electrical circuits and impedance spectra.....</i>	<i>13-22</i>
13.1.4	<i>Impedance spectra from real samples</i>	<i>13-23</i>
13.1.5	<i>Bulk and grain boundaries; the brick layer model.....</i>	<i>13-24</i>
13.1.6	<i>Electrodes</i>	<i>13-26</i>
13.1.7	<i>Mixed ionic and electronic conductors.....</i>	<i>13-26</i>
13.2	SEEBECK COEFFICIENT (THERMOELECTRIC POWER).....	13-27
13.2.1	<i>Overview.....</i>	<i>13-27</i>
13.2.2	<i>The sign convention.....</i>	<i>13-27</i>
13.2.3	<i>Correction for the wire materials</i>	<i>13-27</i>
13.3	VOLTAGE MEASUREMENTS ON HIGH IMPEDANCE SAMPLES	13-28
13.3.1	<i>Use of an electrometer.....</i>	<i>13-28</i>
13.3.2	<i>If you don't have an electrometer</i>	<i>13-28</i>
14	SCHEMATICS, DRAWINGS, INLAYS, ETC.	14-1

1 Introduction

Thank you for using a ProboStat™, and welcome to the manual.

1.1 About this manual

We believe you will find that the main and essential information in the manual is in place. As we have more time and learn from feedback from customers and users, we will refine and extend the manual. New versions will be available for download from our website www.norecs.com.

If you are an experienced investigator of high temperature materials properties, and have worked with similar types of cells and measurements, many items and procedures described here may be familiar to you. You will then need the manual mainly for detail reference and perhaps troubleshooting purposes.

If you are less experienced, we hope our tour through the safety issues will help you avoid some typical beginner’s errors (of which some might be hazardous). Further, the manual will help you check, understand and assemble the different parts in the package. Then we go through the main methods you can use the cell for. Finally, we discuss a few more specialised themes and give instructions for self-fabrication of consumable parts.

1.2 Serial numbers and versions

ProboStat™ is under continuous development, denoted by the letter (presently “A”) and version number. The serial number is printed on the front plate or on the side of the hexagonal box, as indicated in the figure below.

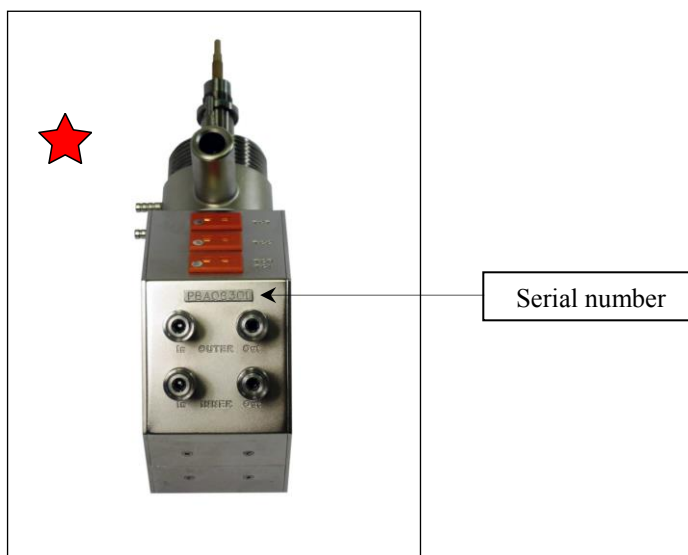

Figure 1-1: Serial number is engraved or posted on the side of the hexagonal connector box

The serial number indicates which version it was shipped as, according to the following table:

Serial numbers:	Version	Serial numbers:	Version
01001-01002	A-0	04101-05007 and 05301-05302	A-4
02001	A-1	05008-05999	A-5
02002-02011	A-2	06001-...	A-6
03001-04099	A-3	15301-15303, 15306	B-6

As long as differences are minor, the manual intends to serve all recent versions. It is thus important to be aware of which version of the cell you have when the manual distinguishes them.

The differences between version numbers within the “A” series are relatively small. Upgrades can thus be done, some of them quite easily. Specific instructions for such upgrades are provided on request.

1.3 *Transportation and warranties*

We take responsibility for the arrival in good order of the cell and its accessories if we are in charge of the transport. Immediately notify us or your local dealer if there is one, and if possible the transporter, if the outer package is damaged upon arrival or if you discover broken parts when unpacking it. (Oval alumina insulation tubes are intentionally assembled of two lengths in the full length version of the cell.)

You furthermore have a 2-years warranty on all parts, except on breakable ceramics and consumable parts in the hot-zone of the cell, and on breakage of the feedthrough mini-contacts.

1.4 *Rights*

We (NORECS AS) own the design of the ProboStat™ cell and the rights to produce and sell it. You may thus not copy the base unit of it. However, buyers may fabricate consumable parts for the cell for their own use, and we provide descriptions and advice for this purpose. Likewise, buyers may copy the manual for their own use. Other uses or reproductions are prohibited without our permission.

2 Safety first

The ProboStat™ is in itself a safe unit – there are no intrinsic hazards. Similar units have been used for 30 years under conditions ranging from pure oxygen to pure hydrogen, at temperatures above 1400°C and in many types of furnaces – without a single accident to date.

However, safe operation requires that the user consider potential dangers and unexpected situations that can be caused by the gases, pressures, temperatures, electricity, and samples that the cell is subjected to. Further, the user must ensure that the unit is used according to local safety regulations.

Regardless of other safety measures, we recommend to use safety goggles or other eye-shield when working with or near the cell as long as there is any chance that it has been fed with explosive gas or that it is at over-pressure or vacuum.

Potential hazards you should consider are:

Explosive and toxic gases

If you use toxic or flammable gases, be sure to connect the cell outlets to a suitable ventilation/hood system, and to have appropriate alarm and shut-off systems in operation in case of leakage or failing ventilation.

Use flammable gases only in concentrations below the explosion limits unless appropriate actions are taken to prevent damage in case of explosion and approval to using such gases is given by your local authority.

Make yourself familiar with symptoms of intake of toxic gases, and actions to be taken. Explosive and flammable gases comprise H₂, CH₄, and others. Toxic gases comprise CO, H₂S, SO₂, NH₃, and others.

Oxygen

Pure oxygen may under certain conditions spontaneously ignite oxidisable materials such as certain metals and organics, and the subsequent reaction may proceed explosively. Thus, keep the interior of ProboStat clean and free of foreign organic materials. Do not apply oxygen pressures above atmospheric.

Overpressure

Do not connect ProboStat to a gas supply line from pressurised gases without having overpressure relief systems in front of the cell. (Pressure relief after the cell is not sufficient, as it does not prevent against pressure build-up in case of closed or clogged gas outlets.) Use a relief system that allows no more than 0.1 bar of overpressure. For pressure relief, we suggest to use a mechanical valve made for this purpose or a column of less than 1 m, preferably 20 cm, of dibutyl phtalate or inert oil connected to the gas line via a T-connection. Between the T and the column insert a volume that can hold the liquid in case of underpressure. Vent for instance to a hood if flammable or toxic gases are used.

Special steel outer tubes can be supplied that allows certain overpressures; see special chapter.

Sub-atmospheric pressure and vacuum

Sub-atmospheric pressures are in general safe in ProboStat. The possible danger and effects of an implosion are limited. However, wear goggles if using a flammable gas at sub-atmospheric pressure (as always with a flammable gas) in case of unexpected intrusion of air.

You must of course not have connected a pressure relief system if you use sub-atmospheric pressure by pumping.

The combination of a pressurised gas supply system and pumping to obtain a controlled atmosphere at sub-atmospheric pressure is particularly difficult in terms of safety measures against every possible error. This requires special consideration and should normally not be used with flammable gases.

Electrical shock

Do not connect potentially dangerous high voltages (>42 V) to the electrical connections of the ProboStat (except – with the appropriate precautions - for the kV high voltage version).

If possible, use furnaces with low or floating voltages. If high voltages are involved, some kind of insulation (e.g. ceramic tube) between the heating element and the cell is preferred. If this is not the case an intact ceramic or silica outer tube of the ProboStat will itself provide insulation. However, the following precautions are recommended:

Ensure that metal parts of the ProboStat cannot be brought into contact with the heating element. If necessary, install extra physical hindrances or insulators to prevent accidental contact.

Ground the metal base unit of the ProboStat. (Use for instance the ground connection screw on the hexagon.)

As with electrical equipment in general, avoid touching a potentially voltage-carrying object with one hand and a grounded object with the other.

If applicable, ask your local electrical safety personnel to approve your installation of a furnace and other surroundings of the ProboStat.

In addition to the possibility of cold-end metal parts contacting the heating element, be aware also of the following: In the case of an un-insulated furnace heating element, the outer tube of ProboStat is likely to touch this, and the voltage will be conducted through the tube wall. If the Pt wires in the ProboStat touch the tube wall directly or indirectly through other parts, the voltage may furthermore appear at the terminal connectors. If the voltage is high, it may also be felt as painful if the connectors are touched by hand. However, the insulation of the outer tube will normally, even at high temperatures, be high and more than sufficient, so that the high voltage will be discharged and zeroed when touched (as with other high impedance sources, like static charge of clothes, hair, etc.). Still, avoid touching terminals with the use of such furnaces at high temperatures, and if possible avoid that Pt parts are in direct contact with the outer wall.

Water leakage

Damage to floors etc. from leakage from cooling water systems is a common problem. Water leakage typically results from hoses and hose connections blown open due to

- Poor and unsecured connections
- Old and/or unsuitable hoses
- Overpressure after inadvertent handling of water tap knobs
- Damage of O-rings *during* water-supply break
- Overpressure due to boiling *after* water-supply break

Take precautions to prevent these causes. Water leakage additionally gives risk for electrical shocks. Always consider that a wet system or water on the floor may be carrying high voltage. Disconnect potential power supplies before touching the water.

Burns from hot surfaces

If you retract ProboStat from a hot furnace, remember that the ceramic outer tube and other parts will remain hot for a long time and give serious burns if touched. Mark it with a warning sign to prevent yourself and others from touching it.

3 Unpacking

Upon receiving the ProboStat package, inspect it immediately. In particular, check that outer packaging is free from excessive damage, that items inside are free from visible damage, and that ceramic parts appear to be free from cracks. (Some oval alumina insulating tubes are deliberately divided.) Report apparent damage to us (e.g. at post@norecs.com) or your local dealer if there is one, and when possible to the transporter.

Check the contents by the descriptions below and by your order. If parts appear to be missing from your order, please notify us at your earliest convenience (e.g., at post@norecs.com).

When handling the parts, be sure not to contaminate them with things you don't want to contaminate your cell and sample later on. For instance, sodium chloride, silicone grease, etc., from your fingers will inevitably evaporate and migrate at high temperatures, contaminate your samples, decrease the lifetime of silica parts, etc.

The systems may be packed in different containers dependent on the number of parts and preferences of the buyer when placing the order.

3.1 Aluminium cases

A “bwh ARK type 6” aluminium case has one handle, no wheels, and is usually used for “Normal system” packages. It contains two layers of inlay material that hold all the parts.

The “bwh ARK type 7” aluminium case, normally used for “Extensive system” packages, is recognisable by its 2 handles and two small wheels. It contains 3 layers.

In both types, the manual is located in the lid of the case.

Gently lift out a layer, using the two cut-out handles, to access the next. Save loose inlay material so that you can repack for safe storage.

Do not attempt to remove the bottom layer – there is nothing underneath.

NOTE: Do not close the case without re-installing all the layers (and the soft foam blocks) that keep those items in place! (Someone might put it upright – with disaster as result!)

3.2 Cardboard boxes

Cardboard boxes are packed more individually. Open from the top as indicated on each box, and lift out foam blocks one by one. Check early on that nothing sticks to the underside of a block before lifting it too high.

Although the cardboard packing is not intended primarily to serve for storage, it may be useful to save the foam blocks that hold ceramic tubes for storage purposes.

4 Contents, construction, configurations and assembly

This section describes the parts and assembly of the cell in rather general terms, touching upon construction, configurations and uses. Details of configurations and uses, as well as instructions for making and assembling consumable parts, are treated also in later sections.

We here make definitions and define abbreviations for many items that we will use later in **boldface**. We will for simplicity refer to the standard version and standard materials. Your system may thus have deviating options in some respects that we may mention directly or leave for special sections or inlays. Important options are:

- Your cell package may have been ordered without some items described.
- Your cell furnishing may be a whole multiple of 10 cm shorter than the standard cell.
- Your cell may be a kV (kilovolt) type, i.e. have some feedthroughs made for kV-range voltages.
- Your package may be specialised in other ways.

We suggest that you refer to the following section while unpacking and inspecting the system and while taking the parts into use for the first time.

4.1 Stand set (if supplied)

Your cell may be delivered with all or parts of a simple lab bench stand, consisting of

Stand. Assemble by screwing the **long steel rod** onto the **base plate**. Tighten firmly. This is used to hold the cell during assembly and sample mounting. It may also be used to hold the cell during measurements if you do not have a suitable rack or mechanism for this purpose.



Figure 4-1: Stand set with base plate, long steel rod, two sleeves and mounting ring. Short steel bar (left).

Sleeve(s) are used to hold the base unit and other items on the stand.

The **mounting ring** is used to surround the cell during mounting to prevent electrodes, thermocouples and gas tubes to fall out and bend/break. It may also be used simply to secure the whole cell against falling over after it has been mounted.

You may of course use your own supply of the above standard items. Preferably use a heavy and steady base plate for a stand. Also, be aware that many common sleeves are unreliable because they have ill-defined end-points due to flat-nosed screws.

4.2 Base unit; construction, functions, and accessories

4.2.1 Base unit

The central unit in the ProboStat system is the **base unit assembly**, made of Ni-plated brass or stainless steel. The circular **base unit** metal block has threads for holding support and outer tubes, it has electrical and gas feedthroughs, water cooling, and underneath a hexagonal shaped **connector box**. Note the 5-digit series number on the connector box. It corresponds to a certain version (A-0, A-1, A-2 etc.) of the cell as specified in section 1 (Introduction).

Various versions have various layouts of the electrical and gas connections on the sides of the hexagonal box. However, the marking and functionality is the same.

A short (15 cm) **steel bar** is provided separately (packed e.g. underneath the mounting ring or base plate) to be inserted in the side of the base unit, after first fully unscrewing the **locking screw**. Fasten and secure the steel bar to the base unit using an enclosed **hex-key** on the locking screw. **Do not apply much force.**

Mount the base unit assembly vertically, resting on the desk or stand base plate, or just above desk level, using the enclosed stand and sleeve (if supplied) or on your own stand or other suitable system.

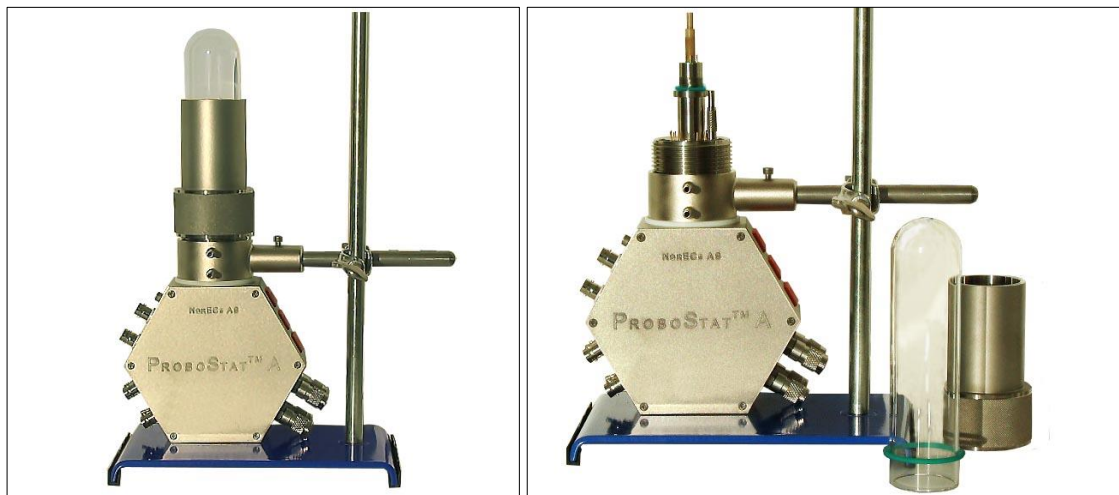

Figure 4-2: Base unit mounted on the stand (left). Enclosing transportation tube removed (right).

Unscrew and remove the **enclosing tube flange** that tightens the O-ring seal around the **enclosing tube**. Then carefully lift off the enclosing transportation tube. Keep the **enclosing tube O-ring**, which should be a 40 x 3 mm Viton type. (Other dimensions may be used for adjustment purposes. Normal rather than Viton may be used, but has less temperature resistance.)

Now, inspect the base unit's features on the upper side:

The thinner part in the centre we shall refer to as the **pedestal**. It has a central **inner gas hose stub** for an inner gas supply tube, an **inner gas return hole**, and four electrical **feedthroughs**.

Down below, around the pedestal you similarly find an **outer gas hose stub**, an **outer gas return hole**, and twelve electrical **feedthroughs**.

Up to version A-5 the inner and outer gas hose stubs are solid metal or PEEK polymer, respectively, not detachable. From version A-6, both the inner and outer gas hose stubs are detachable and replaceable. However, detaching them is not necessary or recommendable for normal use, and intended only for customisation for special uses. If you ever have to detach them, note that the inner stub is threaded (detach by unscrewing) while the outer is of bayonet type (detach by retracting).

All electrical **feedthroughs** are male mini-contacts, sitting in **PEEK insulators**. (If your cell is a high voltage version, two of the feedthroughs are extended and thicker and sit in alumina insulators.) The insulators provide the sealing of the feedthrough. This is sufficient to obtain gas tight and vacuum tight cells, but they are not high-vacuum seals.

The thermocouples and electrode contacts supplied (and that you can also make yourself) have corresponding female mini-contacts. As spare parts the cell comes with extra female **wire contacts** to be soldered to new wires.

The electrical feedthroughs and wiring are described in more detail further down this section.



Figure 4-3: Base unit with pedestal. Version A-6 with replaceable gas stubs. On the pedestal: Gas inlet and outlet and 4 feedthroughs. Further down: Inner O-ring. On the base circle: Gas inlet and outlet and 12 feedthroughs.

From version A-4 the **ring on the pedestal leg** has a **groove underneath** for attachment of springs for the spring load. On versions A-3 and earlier there are a number of small **spring load hook screws** on the pedestal's leg. These are positioned so as to operate in symmetrical configurations of three or two.

4.2.2 Water cooling

Further down and on the outside of the base unit you find **cooling water hose stubs**. These are attached on a **water cooling cylinder** which appears as a part of the base unit block. The cooling water flows between the ring and the central block and is sealed with two permanently compressed **water cooling O-rings** inside. When you later on connect the cooling water, use the lower stub as inlet and the upper as outlet.

(The cell may be delivered with a **cooling water connection set** consisting of two plastic quick-connects pairs and some PVC hose. If you use it, connect the two hoses to the two hose stubs on the cell and then onto both ends of one quick-connect pair. Connect your cooling water supply through the other pair. You can now easily connect the cell by inserting it into the supply line.)

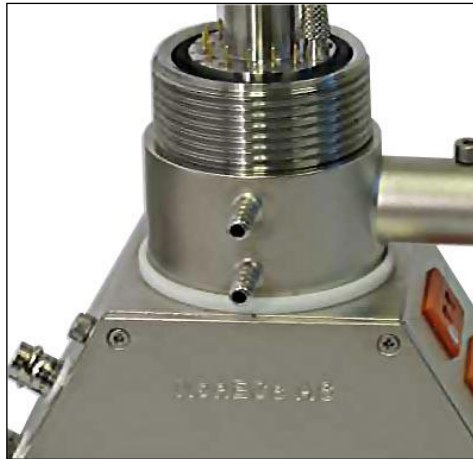

Figure 4-4: Cooling water hose stubs. Use lower as inlet

4.2.3 Connector box and cooling water ring; change angle of the fixation bar

If you are interested to inspect the interior of the connector box, we suggest that you remove either the **front plate** (engraved) or the **rear plate** on the **connector box**.

Moreover, if you want to adjust the angle of the cell to stand you can rotate the cooling water ring that the sleeve is located on. For this you may need to access screws inside the box and thus also for this purpose remove the front and/or rear plate.

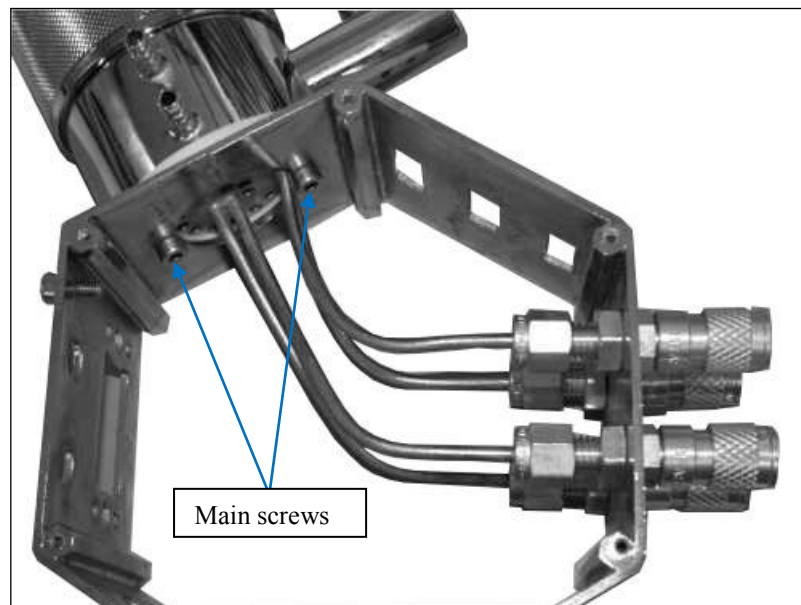

Figure 4-5: Opened connector box (version A-3) showing two hexagonal screws holding cooling water ring and connector box to base unit.

The connector box is fastened to the base unit block through the **main screws**. When you need to access them, do so by an enclosed **hex-key** after removing one of the plates of the connector box. The function of the main screws is to hold the connector box in place, but this in turn also holds the water cooling cylinder in place.

If you at some stage need to turn the water cooling cylinder around to find a good angle for the fixation of the base unit assembly to the stand, loosen the two main screws somewhat until you with some force can turn the cooling water ring. Tighten the screws appropriately again, but don't over-tighten – the final

force of these screws has no significance, including no effect on the leakage tightness of the cooling water ring.

You may actually leave the main screws fairly loose, so that you can adjust the angle of the cooling water ring later without opening the connector box.

The turning of the water cooling ring may be hard even with loose main screws. Carefully apply force onto the turning of the cooling water ring with one hand, holding firmly onto the hexagon or the outer tube sleeve with the other. It may help to know and trust that only the cooling water ring shall turn.

Should the water cooling cylinder become somewhat looser over time during use, there is no immediate danger; the water seal is not affected in principle by this. However, if the connector box itself becomes loose, tighten the main screws to avoid wear on the thread.

After inspection of the base unit assembly, put the plates of the connector box back in place. Each plate must be put back in its original position and direction. Numbers, text and arrows are engraved that will help you achieve this. Insert all 6 screws before tightening any of them. Be sure always to fasten all 6 screws on each side so that the box keeps its shape and continues to fit the holes in the plate. But do not over-tighten.

4.2.4 Gas connects

The connector box has inlet and outlet **bulkhead gas connects**, appropriately marked. They come in different types:

4.2.4.1 Quick-connects

The gas connects are by default Swagelok miniature quick-connects. As standard, they are matched by four enclosed **gas connect stems** for connecting to 1/8" tubing or hose connectors.

Both the stems and bulkheads can be delivered without valves. In this case the bulkheads are marked "MB" after the item code. They remain open when disconnected.

NOTE: Any quick-connect that has a valve should be connected with a matching unit also with valve, in order to open the valve in all cases.

By default we equip the gas IN (inlet) bulkheads with valves. This enables the use of valves on the inlet stems, so that gas stops automatically when the cell is disconnected.

However, we avoid using valves on the OUT (outlet) bulkheads, as this may cause the whole cell to be closed off during heating, creating unwanted overpressure.

When making or opening a quick-connect, push the finger-grip nut on the bulkhead gas connect towards the chassis.

The bulkhead gas connects are made of a material according to your order of gas connection materials. We sometimes deliver these in stainless steel also if the base unit may be brass. With stainless steel you can connect both steel and copper tubing.

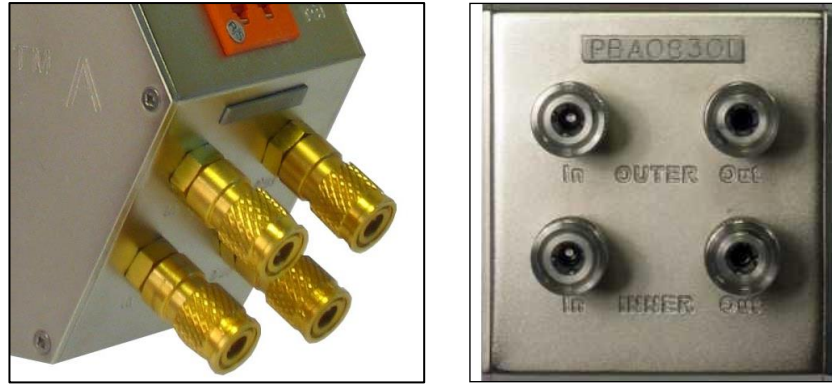

Figure 4-6: Inner and outer chamber gas IN and OUT quick-connects (side and front view).

Swagelok’s “Good Practices for Operation of Swagelok Quick-Connects”:

- Use filters ahead of quick-connects if necessary
- Use body and stem protectors on uncoupled bodies and stems
- Align bodies and stems when coupling or uncoupling
- Couple and uncouple quick-connects at room temperature
- Support hanging hoses or other equipment to prevent side load
- Re-lubricate stem seal O-rings periodically
- Do not rotate while coupled
- Do not insert foreign objects into uncoupled bodies or stems

4.2.4.2 Tube fittings

If you instead of the quick-connects have ordered or installed ordinary Swagelok bulkhead union tube fittings, do not tighten or loosen tube connections without knowing the correct procedures. Equally important, always hold the bulkhead union firmly by its fixed nut at the outer wall of the connector box using a wrench, when you tighten or loosen the nut on the tube side. This is to ensure that the bulkhead union does not loosen from the box wall, as this will put strain on the gas tubes in the box and their seals to the base unit block. Should the bulkhead union nevertheless loosen at some stage, you must fasten it by tightening the nut on the inside of the wall while holding the one on the outside still, not twisting the gas tube in the box further.

4.2.5 How to connect a 1/8” tube to a Swagelok stem or other tube fitting

Since we most often deliver 1/8” tube fittings on our quick-connect stems and other connects, we here mention briefly how to connect them properly for the inexperienced Swagelok user:

First time:

Be sure that the tube fitting has not been opened or otherwise ensure that both ferrules are in place in the correct order and direction. Be sure that the tube end is smooth (cut with an appropriate tube cutter) and straight.

Insert the tube all the way and ensure it remains so throughout the rest of the operation.

Finger-tighten the nut. We suggest you then mark its position relative to the fitting with a pen.

Tighten further ¾ of a turn using wrenches.

After this, the ferrules are permanently fastened to the tube, a couple of millimetres up from its end.

Consecutive times:

A tube with ferrules fastened as above can be repeatedly loosened and refitted to the same or any other same-sized fitting. **When fitting a pre-fitted tube, tighten lightly using wrenches.** Do not attempt any repeat of the first-time operation, and use the gentle force of two fingers on the wrenches, only.

4.2.6 Electrical feedthroughs

An overview of the electrical feedthroughs and wiring is given in the next subsection, including Table 1.

4.2.6.1 Feedthrough codes

The feedthroughs have **feedthrough codes**, consisting of a number and a letter. The **numbers** start on the pedestal and run clockwise (when viewed from above) from 1 to 4, starting on the first one clockwise after the gas outlet hole. The numbering continues on the outer ring from 5 to 16 again clockwise from the first after the gas in- and outlets.

The **letters** denote the normal function of the lead:

- P Positive thermocouple half. For Pt/Pt10Rh thermocouples this is the Pt10Rh lead.
- N Negative thermocouple half. For Pt/Pt10Rh thermocouples this is the Pt lead.
- G General measurement leads. In a standard cell these are Pt leads.

All feedthroughs are connected to sockets at the connector box according to Table 1.

4.2.6.2 Basic use

The most common use of the feedthroughs is as follows:

1. Connect a thermocouple to 11P and 12N according to the colour coding of the thermocouple.
2. For 2-electrode samples, connect the top electrode of the sample to feedthroughs 13G and 15G. Connect the bottom electrode to feedthroughs 6G and 8G, or to 3G and 4G if those wires go inside the support tube. For 4-point samples connect the electrodes, in order, to 15G, 13G, 8G, 6G.

Connections and specific uses are described in more detail throughout the manual.

4.2.6.3 Thermocouple feedthroughs

Thermocouple (P and N) feedthroughs are marked with colour code dots on the base unit. These will follow a standard for thermocouples. However, there are several standards even for one and the same type of thermocouple.

For Pt/Pt10Rh (type S) we presently use:

P (Pt10Rh) = **Black** N (Pt) = **Red**

but also

P (Pt10Rh) = **Orange** or **Red** N (Pt) = White

is in use for type S. Thus, Red may signify both negative and positive – depending on what it is matched with!

NOTE: To repeat the above: *Our conformation with the black-red code for type S thermocouples means that the red pole represents the negative pole of the thermocouple.*

For type K thermocouples (Ni + 10% Cr, positive leg, and Ni + 2% Al + 2% Mn + 1% Si, negative leg) we use the following colour code:

P (Ni + 10% Cr) = **Green** N (Ni + 2% Al + 2% Mn + 1% Si): = White

These colours must be matched with corresponding coding on the thermocouples. If your cell has been ordered with alternative thermocouple types, other colours may apply.

NOTE: The actual colour coding of your particular cell(s) is identified in a filled-in list called "Identifications and specifications" placed separately with your cell. A blank scheme (for alterations) is provided at the end of the manual itself.

4.2.6.4 Compensation wires in the connector box

The leads continue below the feedthrough in a compensation wires with the same thermoelectric properties as the lead material near room temperature. For cells with only Pt and Pt10Rh leads, this means that the P contacts have Pt10Rh-compatible cables connected onwards, while all the others have Pt-compatible cables. Furthermore, the P and N contacts will end up at thermocouple outlet plugs, while the G contacts end up at the BNC sockets. The coding and wiring is described in more detail in Table 1.

The leads in the connector box have plastic insulation with a colour code indicating the type of noble metal or compensation cable it is made of. The coding may follow a different standard than the one used for the external compensation cables and the base unit block.

The physical positioning of the wires in the connector box is to some extent done so as to keep distance between certain wires. This reduces the coupling between wires normally connected to opposite sides of a sample and thus reduces parasitic admittances.

4.2.6.5 Shields and the Shields bridge

Four of the outer G-type feedthroughs (5, 7, 14, 16) are normally connected to the shields of the BNC cables for electrode contacts. From version A-5 these can be connected together (all four) by a **Shields bridge switch** (position Down). The shields bridge provides a current return loop for the current lead shields, as required by some common and advanced impedance spectrometers. Others have it as an option and require disconnected shields (Shields bridge switch position Up).

Many potentiostats have driven shields in which case the shields **must** be disconnected from each other. In this case, disengage the switch (Up).

Refer to your measurement instrumentation and chapters in the ProboStat manual for whether to engage the switch or not.

4.2.7 Sockets and switches on the connector box

The connector box has three female **thermocouple contact sockets** of type corresponding to the thermocouples the cell is designed for (i.e., the type of compensation cable it is equipped with). It is furthermore delivered with up to three **compensation cables**, suitable for connection between the cell and controllers, readout units, or voltmeters. The cables have appropriate thermocouple male plugs connecting to the cell. The user must supply the other end plugs as instrumentation requires.



Figure 4-7: Sockets TCT, TCC and TCB/TCI for thermocouple cables, shown for versions A-3 and later.

The general measurement wires go to **6 BNC contacts**, and the cell is supplied with 4 BNC cables each 2.5 m long as standard.

Standard coaxial cables tolerate 70°C. Special versions can be supplied which tolerate higher temperatures.



Figure 4-8: 6 individual BNC connectors. Shields bridge, Ch+HCS and LC+HCS switches (connects when down).

The connector box may be equipped with up to three toggle **switches**. *All connect when down*. If installed, these have the following functions:

Shields Br. switch: When DOWN this connects all four independent electrode connect shields (HCS, HVS, LVS+ILVS, LCS+ILCS) together. It is included from version A-5 and replaces the mini-contact wire bridge on earlier versions. The shields bridge provides a current return loop for the current lead shields, as required by some common and advanced impedance spectrometers. Others have it as an option. Many potentiostats have driven shields in which case the shields must be disconnected from each other. In this case, disengage the switch (UP).

Ch+HCS switch: When DOWN this connects the base unit chassis to the shield HCS of the high current (HC) terminal. This actively includes the metal block and the connector box in the shielding and guarding

between the leads and towards external interference. (Note that if the HC shield is at ground level from the instrumentation, this connection more or less may already exist in some way via the physical suspension of the cell to a rack, etc.). Refer to your measurement instrumentation and chapters in this manual for whether to engage this switch or not.

LC+HCS switch: When DOWN this connects one of the current terminals, LC, to the HCS shield. This is practical when you use the LC terminal as a guard electrode. As long as you are not using a guard electrode, the default and normal position of this switch is UP.

On the connector box you can also find an **Earth point screw** that you can use for external Earth connections.

4.2.8 Wiring schemes

The following figures show the coordinates, numbering and standard material of the electrical wiring for the base unit feedthroughs (top view, in relation to the gas inlets (I) and outlets (O)). The coding and functions are listed in detail in the table below

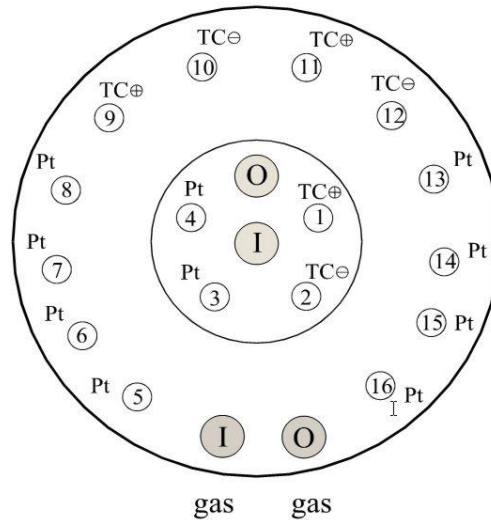

Figure 4-9. Overview of base unit feedthroughs, valid for all versions (top view).*

*For the following base units, the outer In and Out gas paths are swapped:

ProboStat base unit versions			
A-1	A-2	A-6	B-6
All	All	15301	15301
		15302	15302
		15303	15303
		15304	15306
		15305	
		15307	
		16001	
		16301	
		16302	

Table 1. Standard wiring of ProboStat versions A-2 and later. Example with **type S thermocouples**.

Base unit feed-through code	Base unit feedthrough colour code	Standard material in hot zone	Function	Function code	BNC code (S = shield)	Thermocouple contact codes
1 P	Black	Pt10Rh	Bottom/inner TC+	TCB+	-	TCB+
2 N	Red	Pt	Bottom/inner TC-	TCB-	-	TCB-
3 G	-	Pt	Inner low current	ILC	ILC	-
4 G	-	Pt	Inner low voltage	ILV	ILV	-
5 G	-	Pt	Low current shield	LCS	LCS	-
6 G	-	Pt	Low current/Guard	LC	LC	-
7 G	-	Pt	Low voltage shield	LVS	LVS	-
8 G	-	Pt	Low voltage	LV	LV	-
9 P	Black	Pt10Rh	Top TC+	TCT+	-	TCT+
10 N	Red	Pt	Top TC-	TCT-	-	TCT-
11 P	Black	Pt10Rh	Centre/control TC+	TCC+	-	TCC+
12 N	Red	Pt	Centre/control TC-	TCC-	-	TCC-
13 G	-	Pt	High voltage	HV	HV	-
14 G	-	Pt	High voltage shield	HVS	HVS	-
15 G	-	Pt	High current	HC	HC	-
16 G	-	Pt	High current shield	HCS	HCS	-

Table 2. Standard wiring of ProboStat versions A-2 and later. Example with **type K thermocouples**.

Base unit feed-through code	Base unit feedthrough colour code	Standard material in hot zone	Function	Function code	BNC code (S = shield)	Thermocouple contact codes
1 P	Green	NiCr	Bottom/inner TC+	TCB+	-	TCB+
2 N	White	NiAl	Bottom/inner TC-	TCB-	-	TCB-
3 G	-	Pt	Inner low current	ILC	ILC	-
4 G	-	Pt	Inner low voltage	ILV	ILV	-
5 G	-	Pt	Low current shield	LCS	LCS	-
6 G	-	Pt	Low current/Guard	LC	LC	-
7 G	-	Pt	Low voltage shield	LVS	LVS	-
8 G	-	Pt	Low voltage	LV	LV	-
9 P	Green	NiCr	Top TC+	TCT+	-	TCT+
10 N	White	NiAl	Top TC-	TCT-	-	TCT-
11 P	Green	NiCr	Centre/control TC+	TCC+	-	TCC+
12 N	White	NiAl	Centre/control TC-	TCC-	-	TCC-
13 G	-	Pt	High voltage	HV	HV	-
14 G	-	Pt	High voltage shield	HVS	HVS	-
15 G	-	Pt	High current	HC	HC	-
16 G	-	Pt	High current shield	HCS	HCS	-

Note 1: The LC electrode may be used as guard electrode when ILC and ILV are used to contact the inner/lower electrode.

Note 2: The low current shield LCS is distributed to the shields of both ILC and LC BNC contacts. Similarly, the low voltage shield LVS is distributed to the shields of both ILV and LV.

Switch Shields br.: Connects all four electrode connect shields (HCS,HVS,LVS,LCS) together when DOWN.

Switch Ch+HCS: Connects the base unit chassis (Ch) to the HCS shield when DOWN.

Switch LC+HCS: Connects the LC (e.g. as guard electrode) to the HCS shield when DOWN.

4.3 Enclosing (outer) tubes

During transport, the cell is normally equipped with a short enclosing tube. This is a fused quartz tube meant for protection during transport and storage. It is also useful for leak-testing the cell.

You will find one or more **enclosing tubes** for use at high temperatures packed separately. They are 60, 50, or 40 cm long and of 4 cm outer diameter. Before use, check visually that the enclosing tubes are crack-free. Place the outer tube O-ring around the enclosing tube, ca. 3 cm from the open end, then put the tube slowly in place in the base unit (without harming the feedthrough contacts) and then finally slide the enclosing tube flange down the tube and tighten it.

NOTE: If your sample is mounted, with spring load and other inventory in place, the sliding down of the enclosing tube must be done with gentle hands, observing vertical positioning, in order not to shift the sample. At any obstacle or friction down the path, overcome it by relocating or adjusting, never by force!

NOTE: When tightening the enclosing tube flange, it is good if you have the base unit fastened to a fixed stand or if a colleague holds it so that you can hold the tube itself still. This is important if you have a fragile or wide sample assembly or an irregular tube interior so that rotation of the tube may move your sample.

If you have metal outer tubes equipped with thread, they replace the flange. They may be used with or without a ceramic tube inside.

4.4 Sample support tubes

Various ceramic or metallic **sample support tube assemblies** can be delivered for the ProboStat. Ceramic **sample support tubes** are mounted on a metal **support tube socket** by special high-temperature-resistant two-component cement. Metallic support tubes are welded or soldered to the socket.

Sample support tube assemblies presently come in the following standard designs:

20 mm disk sample support tube assembly, for disk samples of diameter 20 mm (and up to 24 mm). As accessories to these sample support tube assemblies are supplied

a 20 mm diameter **centre-holed alumina disk** for support of samples of size 6 - 20 mm,

a 20 mm diameter **alumina disk** for support of samples where the electrode contact is made from the outer chamber (and where gradients as in emf measurements are not possible). **The latter disk is also suitable as dummy sample for practising or “zero conductivity” sample for test/reference purposes.**

Bar sample support tube assembly, 20 mm diameter, for bar shaped samples of length up to 50 mm. This support is accompanied by

cut alumina disk, 20 mm diameter, with arc cut off. This disk is used as bar sample support **floor**,

short alumina rod(s) for bar sample spring force, pressed down by the spring load top plate or top cylinder, and acting as the **roof** over the sample top electrode.

We may also deliver support tubes in other dimensions:

15 mm disk sample support tube assembly

12 mm disk sample support tube assembly, for disk samples of diameter 12 mm. Restricted space for gas and electrical connections inside.

10 mm disk sample support tube assembly, for disk samples of diameter 10 mm. Very restricted space for gas and electrical connections inside.

24 mm disk sample support tube assembly, for disk samples of diameter 24 mm. Restricted space for gas and electrical connections **outside**. Extra slim spring load assembly and gas supply tubes are needed and supplied with this support tube.

In addition, special designs for special sample geometries may be made upon order, or assembled by the user. For this purpose, we may deliver extra, unassembled support tube sockets.

Support tubes of other materials than alumina may be delivered. Examples comprise calcia- or yttria-stabilised zirconia, quartz, and a range of metals (typically brass or stainless steel).

Sample support tube assemblies are mounted onto the pedestal of the base unit, with an **O-ring** as seal. This should be either a 16 x 1.5 mm or 15.6 x 1.78 mm Viton type. (Other dimensions may be used for adjustment purposes. Normal rather than Viton O-rings may be used, but have less temperature resistance.) Be careful to align the sample support tube assembly properly so as not to harm the threads of the pedestal.

For the pre-assembled sample support tube units, and especially if you build your own, it is important that they are made straight, so that they will be in the centre of the outer tube.

4.5 Gas supply tubes

The ProboStat is supplied with various **gas supply tubes**. These are to be used inside the cell to supply gases to the lower/inner and upper/outer chambers of the cell. They send the gas directly to the sample area, while extraction of the gas takes place at the bottom of each chamber. Alternatively, gases may be supplied at the bottom and extracted directly from the sample through the tubes (especially for faster response and less after-reactions for gas analyses).

There are three standard types of gas supply tubes delivered with the ProboStat. They are all to be attached to the gas hose fitting inlet by the use of a short length of **silicone hose** (3×5 mm), supplied with ProboStat.

Be sure not to mix up silicone and PVC hoses! The silicone is milky, while the PVC is clear.

The **inner gas tube** is a straight alumina tube of a certain length, either open or as a wider multibore tube. For the thinner open tubes, it is fixed to the hose directly, while the wider ones go via a glued-on PEEK socket. The tube delivers gas to the lower face of a disk sample. In addition, it serves, via the slightly compressed silicone hose, to press the inner electrode lead pair in contact with the lower electrode. Instructions for installation and use will be given in a later chapter.

The **straight outer gas tube** is an alumina tube, which delivers gas to the outer chamber, and is to be used for general purposes and in any case when the temperature is too high for silica to be used.

The **bent quartz tube** is another means to deliver gas to the outer chamber. The bend enables gas supply directly onto the upper face of a disk sample. It should be used when there are gradients over the sample and the temperature allows use of quartz. Instructions for installation and use will be given later. Even

when used at acceptable temperatures, the quartz tube will become white and brittle after temperature cycles to lower temperatures, and should be replaced and thus considered a consumable. You may thus consider getting a number of spares from us or from a local glass workshop or learning to make them yourself.

All the standard types of gas supply tubes are 4 mm outer diameter (or 8.5 mm for inner gas tube of multibore type, delivered with 20 and 24 mm support tubes).

If you are going to use 10 or 12 mm support tubes, you need a thinner inner gas supply tube. Similarly, if you use the 24 mm support tube you need a thinner outer gas supply tube. For these purposes, we deliver tubes in 3 mm versions. The thinner tubes are fitted with a smaller silicone hose dimension (2×4 mm). This still has to fit onto the same, 4 mm gas taps at the base unit, which may require some extra force and pre-widening.)

4.6 Spring load assemblies

Many measurements can be done by wrapping or painting electrodes to samples, or by sealing samples onto supports. There is then often no need to apply a force to hold things in place. However, ProboStat is designed to make use of spring load that allows sample and electrode contacts positioning and replacement in principle without need to break up glues, seals, paints or wrapping.

The ProboStat is equipped with different spring load assemblies for different purposes:

4.6.1 Alumina triangular top plate spring load assembly

The standard triangular top plate spring load assembly is used to press disk samples against the sample support tube and thereby also to hold electrode contacts in connection with the sample electrodes. It is also used to press the roof bar down onto bar samples.

A triangular top plate spring load assembly consists of:

- A triangular alumina top plate
- 3 small 2 mm diameter alumina locking tubes each with fixing 0.5 mm Pt wire (25 mm long)
- 3 long 4 mm diameter spring load alumina tubes
- 3 steel springs (colour coded for stiffness)

The **alumina top plate** comes in two sizes, for up to 20 mm diameter samples and up to 24 mm samples.

The **spring load alumina tubes** go in the three rim holes of the top plate and are locked by **small alumina tubes**. In addition we recommend fixing each small rod to the long rod by the 25 mm long 0.5 mm diameter Pt wire threaded through the small rod and into the top hole of the long tube. The long tubes may be shipped with the small tubes pre-fixed in this way. To use this assembly you must thread the long tubes down into the top plate and then hook a steel spring onto each.

4.6.2 Two-rod van der Pauw spring load assembly

A two-rod van der Pauw spring load assembly is used to press the four electrodes of a van der Pauw type conductivity measurement against the upper sample surface. The assembly consists of two **spring load alumina tubes**, two **steel springs**, and an **alumina bridge bar**. The bridge bar penetrates and holds down two van der Pauw contact tubes, which have holes for wrapping electrode leads, and form part of the VDP2 electrode contact assemblies. The design ensures transmission of the spring load to all four-electrode point contacts.

Also the van der Pauw spring load assembly may be made of **Kanthal wire**, in which case the Kanthal wire is threaded through the bridge bar and this laid above the contact tubes rather than inserted through them.

4.6.3 General concerns regarding spring loads

A word of warning: Our spring loads have advantages in terms of single end assembly, simple design, high temperature tolerance, economy and replaceability. However, they are vulnerable to breakage and may be considered difficult to handle in the beginning. Most users need some practice before mounting of samples becomes secure and reproducible. We suggest that you practise with a dummy sample and that you early consider how you will replace broken alumina tubes: By ordering spares from us, building up a supply, or buying tubes and learning to drill the necessary holes in them. We recommend to buy a finger-tip-held high-speed mini-drill and diamond bores and mini-sawblades for this purpose. We sell suitable selected diamond bores and blades. Remember to saw and drill with water-cooling.

We remind you that the above were the outer spring loads, all pressing the sample and electrode contacts down. Contacts to the inner electrode may be made by using the compression of the inner gas supply tube silicone hose as upward force, letting the gas tube press the contact onto the bottom electrode.

4.7 Thermocouples and electrode contacts

With its standard mini-connectors in the base unit, ProboStat can be furnished with thermocouples and electrode contacts made by the user. We may supply the mini-contacts.

ProboStat may also be delivered with a number of pre-fabricated thermocouples and electrode contacts for the high-temperature zone, to be described in the following. The user is free to copy these or order spares. In the following we mainly refer to standard versions. For deviating materials and dimensions substitute as necessary, and ask us if in doubt.

NOTE: All thermocouple and other wire ends are equipped with physically identical contacts that fit onto all feedthrough contacts at the base unit. Refer to Table 1 and to the markings on the base unit and on the thermocouple and wires for correct connection and polarity.

Use the enclosed or similar pliers or tweezers for the contacts and do not use excessive force.

NOTE: Use the mounting ring above the base unit while setting up the electrical contacts and thermocouples to prevent them from falling down and bending/breaking.

The figures below show overviews of electrode contacts and thermocouples that may be supplied with ProboStat.



Figure 4-10. Alumina/Pt electrode contacts and Au gaskets typically supplied with a normal system in version A-6. From left: Multibore alumina gas supply tube (for use with 20 and 24 mm sample support tube) and INH2N12 inner two-wire electrode contact with net and “finger”. Two GP2N# general purpose electrode nets of different diameter with clip on to GP2 2-wire contacts. Two H2N# two-wire “hand” electrode contacts with net, GR# guard-ring/reference electrode contact, 2 gold gaskets for sealing, and 2 Pt# nets for general contact purposes.

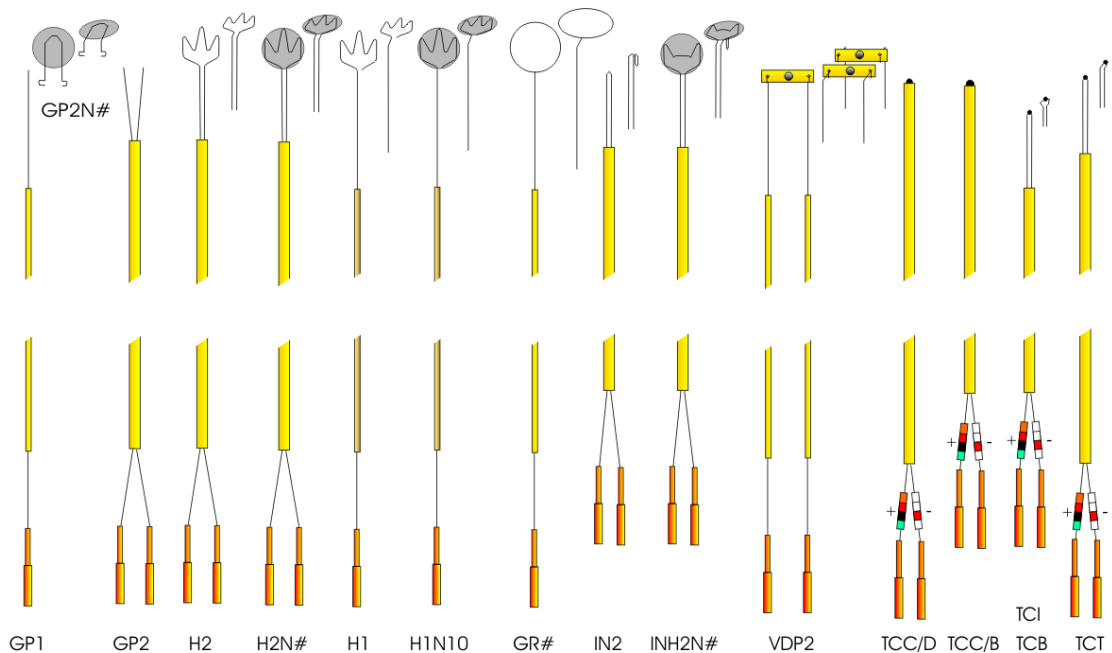

Figure 4-11. Schematic overview of standard electrode contacts and thermocouples. Bending during assembly is indicated where appropriate. GP=general purpose. N=net. H=hand, GR=guard ring, IN=inner, VDP=van der Pauw, TC=thermocouple (C=control, B=bottom, T=top). H1 comes in various lengths: H1BN10 (short), H1TN10 (long), both equipped with Pt net. TCC comes in two lengths: TCC/D (long) for disk samples and TCC/B (short) for bar samples. TCC/B = TCI for serial numbers #02001 and later.

4.7.1 Thermocouples

The thermocouples have denotations starting with TC. They are contained in double-bore “capillary” alumina tubes, have open, welded junctions, and have a pair of contacts fitting the appropriate feedthrough contacts in the base unit.

NOTE: **The contacts are identical for positive and negative wires. It is therefore critical that you observe and use the colour coding.** Further, always check correct behaviour of any controlling thermocouple during initial heat-up of a newly assembled cell. Unfortunately, colour-coding schemes in use for thermocouples are not universal or coherent. Several schemes are in use and often diverge from commonly accepted colours of positive and negative poles. The supply of wire of the various standards varies and thus we need to be prepared for varying coding systems:

Black and red (Pt/Pt10Rh):

Black wire insulation and colour dot signifies Pt10Rh (positive) pole.

Red wire insulation and colour dot signifies Pt (negative) pole.

When this is used in compensation cables it has green common outer insulation.

Orange and white (Pt/Pt10Rh):

Orange wire insulation or colour dot signifies Pt10Rh (positive) pole.

White wire insulation and colour dot signifies Pt (negative) pole.

When this is used in compensation cables it has orange common outer insulation.

Red and white (Pt/Pt10Rh):

Red wire insulation or colour dot signifies Pt10Rh (positive) pole.

White wire insulation and colour dot signifies Pt (negative) pole.

When this is used in compensation cables it has white common outer insulation.

The red colour can thus be used for both positive and negative poles depending on what colour it is matched with!

Green and white (K-type, NiCr/NiAlMnSi)

Green wire insulation or colour dot signifies Ni10Cr (positive) pole.

White wire insulation or colour dot signifies Ni2Al2Mn1Si (negative) pole.

The **control thermocouples (TCC)** have lengths that make them reach to the middle height of the samples. They are used for reading the sample temperature and are suitable for controlling the temperature of the cell. They come in two lengths; long for disk samples (**TCC/D**) and short for bar samples (**TCC/B**). However, since they in most cases have the same functionality and connections, we will often refer to them with the common term TCC.

The cell is delivered with small closed **15 cm long alumina tubes** (6 mm outer and 4 mm inner diameter), which may be used to cap the TCC and thereby protect it from contamination and evaporation.

The **inner thermocouple (TCI)** has a length that makes it reach close to the bottom of a disk sample. It is used to monitor the temperature on the inside/lower side of the sample, for comparison with the temperature of the outer control thermocouple (TCC). It is not required other than in checking/minimising temperature gradients of disk samples. Also this may be capped with the closed 15 cm long alumina tube,

providing the support tube is wide enough. In later productions of ProboStat (serial numbers of 02001 or larger) TCI is identical length with TCC/B and only one is supplied, as they would never be used simultaneously.

The **bottom thermocouple** (TCB) is designed to be used in Seebeck coefficient measurements where the thermocouple can be positioned at the bottom electrode of the bar sample. It has some uncovered length of wire to allow putting the junction at the very electrode.

The **top thermocouple** (TCT) is designed to work in the same manner as the corresponding bottom thermocouple (TCB), but on the top electrode of a Seebeck coefficient bar sample.

The TCB and TCT primarily measure the temperatures. By correct internal or external re-connections, one of the leads from each (of the same material/polarity) may also be used to probe the thermovoltage over the sample, provided the thermocouples are in contact with it. Further, use of one or both leads from each couple may be used in conductivity measurements. However, ProboStat is designed to have voltage and conductivity measurements primarily done via dedicated electrode contacts.

4.7.2 Electrode contacts

The electrode contacts for electrical measurements come in a variety of types. Many of them are issued in 2-wire pairs; one for current and one for voltage. Your order may contact a selection of them.

Only two types are for inner chamber feedthroughs:

The **inner electrode contact 2-wire assembly** (IN2) is fed through an oval two-bore “capillary” alumina tubes. **It is designed to be bent and put into the inner gas supply tube a few mm so as to be pressed by the compression force in the hose upwards and into contact with the lower electrode of a disk sample.**

The **inner “hand” electrode contact 2-wire assembly** (INH2N12) is also fed through an oval two-bore “capillary” alumina tube and is designed to contact the lower electrode of a disk sample, pressed up by a multibore alumina gas supply tube. The electrode contact is shaped as a hand of diameter 10 mm. The middle “finger” is bent down to fit in one of the gas hole of a multibore gas tube. The contact with sample electrode is made by compression force from the hose beneath.

All the remaining electrode contacts are to be fed from the outer chamber:

Outer “hand” electrode contact 2-wire assemblies (H2N#) are fed through two-bore “capillary” alumina tubes and are designed to contact either of the electrodes of a disk sample from outer chamber feedthroughs. The exact fit to the height of the lower and upper electrodes is made by slight bends of the wire legs. The electrode is shaped as a hand to make current distribution to a 10 mm diameter area as standard. They are equipped with electrode nets of various diameters to increase the current distribution and then have denotation **H2N#**, **where # is net diameter**.

Outer “hand” electrode contact 1-wire assemblies (H1BN10/H1TN10) are fed through single-bore alumina tubes and are designed to contact end electrodes of a bar sample from outer chamber feedthroughs. The electrode contacts are shaped as a hand of diameter 10 mm. They are equipped with electrode nets of 10 mm diameter and then have denotation H1BN10 and H1TN10.

The **guard-reference-ring electrode contact assembly** (GR#) is fed in a single-bore alumina tube. **It forms a ring for contacting the lower rim of a disk sample to serve as a surface guard or as reference electrode. In the code, # is the diameter (in mm) of the ring.** This is ca. 2 mm less than the outer diameter of the sample support tube it is intended for.

General purpose electrode contact single wire assembly (GP1) are fed in single-bore alumina tubes. They have sufficient length for versatile connections to wires wrapped or contacted in other ways to samples at different heights. They are mainly intended to contact wires wrapped around bar samples or replaceable electrode contact nets with short terminal wires.

General purpose electrode contact open wire assembly (GP2) are fed pairwise in double-bore “capillary” alumina tubes. They have sufficient length for versatile connections to wires wrapped or contacted in other ways to samples at different heights. They are mainly intended to contact the short terminal wires of the replaceable electrode nets GP2N#.

General purpose electrode contact nets (GP2N#) with short contact wires may be hooked onto the general purpose wires and replaced as part of sample exchange or when contaminated. This promotes sample cleanliness and also helps to minimise the consumption of platinum.

van der Pauw electrode contact pair assemblies (VDP2) are fed in single-bore alumina tubes and wrapped pairwise into small holes at the ends of alumina van der Pauw contact tubes. Use with the van der Pauw spring load assembly (a bridge bar and two spring load tubes).

4.8 Accessories (some optional)

The items may in some cases also be mentioned in the preceding sections. Boldface below indicates items normally supplied:

Alumina spacer rings of diameters corresponding to the sample support tubes. These have various uses:

placement around a small sample resting on a larger support plate, to prevent electrode short-circuits between upper and lower electrode contacts,

placement between a sealed sample and the spring load top plate

to concentrate the load on the sample's rim (where the seal is), and/or

to create a gas volume above the sample to allow gas passage and mixing,

to act as spacers to increase spring load force.

Gold gaskets for sealing concentration cells. They have diameters ca. 2 mm less than the outer diameter of the sample support tube they are intended for.

Ceramic or glass wool/cloth for heat shields.

General purpose thin platinum wire, 0.25 mm diameter, for
various sample contacting purposes, e.g. wrapping bar sample electrodes,
wrapping up insulator tubes of electrode contacts and thermocouples around the sample support tube,
wrapping heat-shielding ceramic or glass cloth around the support tube,
etc.

Closed 15 cm long alumina tubes used to cap the control thermocouples (TCC) or an inner thermocouple (TCI) and thereby protecting them from contamination and Pt evaporation.

Cooling water connection set. This consists of two lengths of plastic (PVC) hose fitting the cooling water taps of the cell, and two sets of plastic male/female quick-connects with variable-size hose flanges. These are useful for fitting the cell to your local low-pressure cooling water hose dimensions and for quickly closing and opening the cell and feeding loops for removing and reinstalling the cell.

Tools suitable for the assembly of the cell, comprising
1 hexagonal key for base unit assembly
Regular screwdriver for connector box plates, etc.
Small pliers for base unit feedthrough connectors, wire connections, and wire adjustment.
Tweezers for spring fastening, electrode contact manipulation, etc.

Conversion adapter(s) for BNC connectors

Extra O-rings

Extra support tube sockets for self-assembly of sample support tubes

Extra ceramic parts of various kinds for self-assembly of supports or electrode contacts

Extra base-unit feedthrough female mini-connectors for self-assembly of electrode contacts.

5 Maintenance

5.1 Cleaning

Fingerprints and general contamination can and should be washed off from ceramic and metallic parts, using a cloth wetted with a volatile organic solvent, such as isopropanol.

In particular, wash off fingerprints on quartz parts prior to exposure to high temperatures – salt accelerates the phase transformation that may eventually ruin quartz parts.

Contaminants on alumina parts after high temperature reactions and diffusion can be attempted removed by grinding with diamond tools. (SiC paper and other general grinding materials will only remove loosely bonded material, as they work away the alumina itself only slowly.) Contaminants that have diffused into the alumina are generally impossible to remove: You should replace the part or use it only in less critical applications, e.g. at temperatures too low for any out-diffusion of the dissolved contaminants. Many contaminants are easily detected by discolorations of the alumina, typically Cr – red, Co – blue, Mn – brown, Fe – yellowish brown. However, many leave no colour prints, such as the basic alkaline and alkaline earth cations, which easily react with alumina.

Sintered alumina as used in ProboStat is generally insoluble in both strong acids and bases. Thus, trying to wash out contaminants by acid or alkali baths is most often useless.

5.2 Platinum parts

Platinum wires in the hot parts of the cell may become contaminated and brittle. Replacement is of course the best, but if economy is an important factor, the Pt wires may often be revitalised by glowing in air. This drives out hydrogen and some other gases, re-crystallises the wires, and gives them much of their softness and strength back: Suspend the wire freely from a clip on e.g. a stand of some kind. Preferably clip a small weight onto the end. Then heat it till yellow glow by a gas burner. By this it should soften and straighten. This method is also good for Pt wires which have been bent too much and which are to be threaded into a capillary insulation tube.

Warning: Do not wash Pt parts in ultrasound baths; the metal pulverizes!

Replaced Pt parts should not be disposed of, but should be recycled - you may get back typically 2/3 of new value. It can be sold to local goldsmiths, refineries or companies specialising in trading second hand noble metals. The manufacturer of ProboStat will take back second hand Pt only as part of a sales agreement on replacement Pt parts.

You may replace Pt wires or thermocouples, by buying replacement assemblies from the manufacturer of ProboStat, or by using your own Pt wires, which you then have to cut, thread in insulation capillaries, and connect to a mini-contact.

If you buy your own Pt wires, we recommend you use only thermocouple quality for all wires, not only for the thermocouples.

We suggest you use the possibility to hook small, sacrificial Pt electrode contacts onto contact leads, so that you only have to replace the former when they are contaminated. Such contacts are supplied with ProboStat for ordinary area electrodes (GP2N#), and are easily made by you in the case of van der Pauw or bar sample electrodes. When you attach the sacrificial contacts, make a 2 mm, 180 degrees bend at the end of the sacrificial part, hook it around the long (straight) Pt wire, and clamp it with the pliers. Since ProboStat may utilise four lead measurements, the contact resistance is not critical for impedance measurements. If you want to ensure a better contact, you may glow the contact point (it will anyway heal by itself at high temperatures) or you may twist the two wires more thoroughly together, or even weld. When you need to remove and replace the sacrificial part, and it does not come off easily by untwisting, we suggest you cut it at the sacrificial part's legs as close to the long wire as possible. In this manner the long wire can be used many times.

5.3 O-rings

For greasing the O-rings, never use high-vacuum, high temperature silicone grease, as it may end up in the hot part of the cell, e.g. via fingerprints and contaminate your sample with silicon. Instead, use an all-organic, silicone-free vacuum grease.

5.4 Lubrication

We suggest that you very slightly lubricate the two screws fastening the multi-cable plug to the counterpart outlet at the cell: Apply a droplet of fine oil at the tip of the thread end of each screw every year or if it starts becoming hard to turn.

The thread of the enclosing tube ring and of the sample support tube rings may similarly be lubricated slightly if they start getting hard to turn.

Be careful not to spill oil elsewhere. No other mechanical parts should need lubrication.

5.5 Storage

If ProboStat is to be stored or out of operation for a long time, it is suggested that you get all water out of the cooling system (e.g. by pressurised air or vacuum) to reduce the chance of corrosion.

The gas lines could also well be checked before storage to ensure that they are clean and dry. If you for instance suspect that salt droplets from a bubbler may have settled in the line, flush it with water and then dry with pressurised air.

6 Specifications

6.1 *Materials*

For specifications of the materials used in your particular cell, refer to the table "Identification and Specifications". If in doubt, please contact us (e.g. at post@norecs.com) for details on materials or constructions.

6.2 *Maximum temperatures*

6.2.1 Hot zone parts

The temperature tolerances in the hot zone are in principle limited only by the materials there, but also the time of exposure and the atmosphere are important factors. In the standard version we have alumina and Pt and Pt10Rh in the hot zone. This typically limits the use to 1400°C (long term) to 1600°C (short term).

6.2.2 Cell interiors in the cold part

The inside (upper face) of the base unit contains parts which all tolerate 165°C, although their lifetime may be reduced and evaporation increased at this temperature. The parts most exposed and vulnerable to heat radiation damage are the parts on the pedestal in the centre of the cell base unit: O-rings, solder, PEEK parts. If employing very high temperatures, it may be necessary to shield the exposed parts of the base unit from heat radiation, as described in the section on experiments.

6.2.3 Entire ProboStat unit

The standard ProboStat base unit tolerates 70°C for extended periods. The high-temperature version of the ProboStat base unit consists of the low and high temperature parts and tolerate 70°C and 165°C accordingly.

The standard base unit can thus be built into a cabinet heated to up to these temperatures to handle wet gases with high dew points, to handle gases with other components likely to liquefy, or to dry or degas the system. The high-temperature version has built in heating system maintaining elevated temperatures.

The external coaxial cables nominally tolerate 70°C. Should it be desirable to heat the entire unit to higher temperatures, coaxial cables with higher temperature tolerance can be delivered by special order.

6.3 *Pressures, vacuum, leakage rates, atmosphere purity*

NOTE: The specifications referred to here are tentative and qualitative estimates. If you require accurate specifications, please ask for an update (e.g. at post@norecs.com).

The cell is designed to operate at ambient pressure or slight overpressure. This means that the outlets of the cell should go to ventilation/hood without any significant obstruction. A considerable overpressure may cause the outer tube to be pressed out of its O-ring fitting.

The overpressure that can be applied depends on how tight the O-ring fitting is fastened, how much the O-ring is lubricated, and the friction (roughness) of the tube surface. The function of such overpressures is most often to provide visual verification (e.g. by bubbles) of gas flow, to reduce in-leakage and back-diffusion to the cell, and to fine-adjust pressure and flow differences between the two cell chambers.

Small overpressures are typically provided by letting the cell outlets pass bubbling stages of 1-20 cm water (or mineral oil or other non-volatile liquid) which increases the total pressure by 0.001-0.02 bar. Be sure to have volumes between the cell and bubbler that can take up all fluid in case of back-flow.

The ProboStat can be delivered with stainless steel outer tubes that operate standalone or outside the ceramic outer tube and allow overpressure up to 15 atm to be used depending on temperature and steel quality.

The cell can hold pumped low-vacuum, but is not designed for high-vacuum. The leakage rate of air into the cell is typically 10^{-6} ml_n/min/Pa or 0.1 ml_n/min/bar (version A-2 and earlier, serial numbers of 02010 and lower). On serial numbers of 02011 and higher and for versions A-3 and later the leakage rate has been diminished by a factor of about 100 by applying an extra polyacrylate sealing of the feedthroughs.

If pumped through 1/8" tubing on one of the sample gas connects, the vacuum reached is typically 0.01 mbar or lower for versions A-3 or higher.

The attainable pumped vacuum can be improved by pumping more efficiently (i.e., minimising the length of 1/8" tubing and using two or more connects in parallel, or by using an open outer tube with a top-flange).

The PEEK feedthrough insulators represent the weakest point in terms of leakage and the vacuum level. By extra sealing of these it is possible to improve the vacuum by an order of magnitude in our experience.

Unless you take special precautions and make own checks, we suggest you assume that a dry, inert gas run through any single-walled cell (ProboStat or others) operated at high temperature will typically attain water vapour levels of 30 ppm and oxygen levels of 10 ppm.

6.4 Electrical specifications

6.4.1 Open circuit parasitic admittances

Typical open circuit admittance of the base unit alone (measured through a 2 m long BNC/coax multicable at 100 kHz) is characterised by a capacitance of 0.6 pF with "Ch+HCS" closed and 2 pF with "Ch+HCS" open.

The corresponding open circuit capacitance with support tube and IN2 and H2N# electrode contacts in place (but without sample) is around 5 pF ("Ch+HCS" closed) with the use of a ceramic support tube. **By using a metallic support tube, the extra parasitic capacitance is eliminated, and the parasitic of the base unit alone again applies.**

The parasitic conductance measured in a similar way is less than 1 nS (resistance above 1 Gohm).

Typical actual admittances between two electrode contact wires when the shields are not connected to the shield system of the impedance analyser (and thus not guarded) are characterised by capacitances of 200 pF and conductances less than 1 μ S (1 Mohm). **The actual admittance may be lowered if the shields are disconnected from each other.**

6.4.2 Short circuit impedance

Series short circuit parasitics from the wires are alleviated by using 4 wires. In 2-electrode measurements spreading resistance in the electrode comes in addition, but is alleviated in 4-electrode measurements.

The inductance of the cell is similarly given by the measuring wires and **is in principle largely alleviated by using 4 wires.** However, **even 4-wire measurements tend to include a small series inductance assigned to artefacts by the impedance spectrometers and wiring used.**

A typical resistance through one lead of coaxial cable and up the base unit is 0.1 ohm.

A typical resistance in the connecting wires in the hot zone is of the order of 1 ohm (for a 0.5 mm diameter Pt wire of length 60 cm twice (up and down the cell)).

6.4.3 Maximum voltages

For safety reasons, the maximum voltage allowed between terminals of the base unit is set to 42 V, which is around the limit for low-level, safe voltages. It is also the maximum DC bias voltage of common impedance spectrometers.

For higher voltages, special safeguarding against electrical shock must be made.

The breakdown voltage of the unit (where sparks or dielectric breakdown of the insulation will occur) has not been determined at present. It will depend on temperature and humidity.

The maximum voltage specification of the Phoenix multi-connector is 125 V (early versions only).

A special version of the ProboStat is available on special order, in which two of the feedthroughs, contacts, and sockets are replaced by high voltage versions, tolerating 10 kV.

6.4.4 Maximum currents

The maximum current applicable in any lead and feedthrough is nominally 1 A, given by the specifications of the BNC contacts. In practice, they will tolerate a few A for limited lengths of time (and are replaceable). The ProboStat can be equipped with extra banana-jack sockets for higher-current compatibility.

The mini-contacts of the feedthroughs tolerate nominally 3 A but also they can take more in practice for limited times. One may use pairs in parallel to increase the capacity.

One must be aware that a limiting factor for high currents may be the heat evolved in platinum wires in the hot zone, and the transfer of this heat into the mini-contacts. Use of gold wire for at least some length close to the base unit will help.

NORECS can deliver special contacts, feedthroughs and hot zone wiring for up to 10 A current.

7 Checks before measurements

Below, some tests are recommended before measurements. Some are for safety and conservation of the equipment, but most are for the purpose of control of the quality of your measurements and conditions.

7.1 *Electrical wires*

For the following tests, a multimeter is sufficient. You may normally and for convenience use a function, which beeps if there is contact. If you have no such option on your multimeter, use a normal resistance measurement. In this case, $< 2 \Omega$ is accepted as contact, while over-range or a resistance in the $M\Omega$ range is accepted as non-contact (open circuit).

Note that if the cell is not at room temperature, DC readings of resistance as in a multimeter may come out with an error due to thermovoltage, especially if measuring over a thermocouple. If you measure a negative resistance or otherwise suspect that the reading is erratic, try to measure with reversed polarity. If the measurements are different, there is an offset voltage, and the correct resistance is approximately the average of the two measurements.

Have the cell and sample assembled, preferably at room temperature, with the measurement multi-cable and thermocouple compensation cables inserted, and with all connections otherwise open. If connector box switches are installed, have them at open (non-contact) position (UP). Then check the following cases of contact or non-contact:

All installed thermocouples should show internal contact.

All deliberately connected measurement leads, such as leads pair-wise connected in two- and three-electrode setups, should show contact.

All measurement leads not deliberately contacted should show no contact, or contact approximately as expected from the sample conductivity at the temperature in question.

All shields should be in contact with each other.

The shield system should not be in contact with the base unit block.

No measurement leads should be in contact with the shields.

If you have connector box switches installed, close switch Ch+HCS and check that you get contact between the shield system and the base unit block. Further, close switch LC+HCS and check that you get contact between lead LC (at the BNC) and the shield system. Open the switches, or leave them at the position you will use them in.

7.2 *Thermocouple operation, calibration, and temperature profiles*

7.2.1 General considerations and preparations

When starting to use a new cell and/or a new furnace, check the operation of the system to avoid destroying it by overheating caused by an error in the thermocouple or controller. You may also need to determine the centre of the hot zone or possibly determine the temperature profile around the sample.

While the temperature profile of the furnace can be measured without the cell in a normal manner, the profile may change with the cell inserted, and you can thus well measure it using the cell. For additional realism and possibilities, we suggest you have a sample or dummy sample with the proper dimensions in the cell during these tests.

In order always to know where your sample is in the furnace, it is good practice to measure the height from the bottom of the base unit to the top of the support tube (where the sample is) and write it down, e.g. at a sticker on the cell itself.

Before starting, cap the unused end of the furnace using e.g. a ceramic plug, and put cooling systems (e.g. cooling water of cell and furnace) into operation.

For the tests you need the cell with one, two, or three thermocouples installed, a temperature controller and a milli-voltmeter, high-resolution voltmeter or temperature display unit with thermocouple input. In addition, a sample can be installed, as this gives a more realistic measure of the temperature profile under use, and in addition lets you follow the temperature gradient over the sample by the voltage over it (utilising the sample's Seebeck-coefficient).

Mount the sample and place the control thermocouple (TCC/D or TCC/B) along it, aligned at the middle of the sample's height. If you use an additional inner/bottom thermocouple (TCI or TCB), place it close to the sample's bottom, and if you are using an additional top thermocouple (TCT), place it close to the sample's top.

If you intend to work mainly with high temperatures (regardless of sample), or if the sample is likely to contaminate the thermocouples by evaporation, cap the TCC and, if possible and applicable, the TCI, with the closed alumina tubes supplied with the cell. If you intend to work at low temperatures (say, below 600°C) do not cap the thermocouples (at least not the central one) as this reduces the thermal coupling between the furnace and thermocouple.

7.2.2 Check of proper temperature control

Insert the cell in the furnace at the position where you believe the sample is at the centre of the hot zone, based on the measurement of the height from base unit to sample. Connect the control thermocouple (normally TCC) to the controller and set it to a moderately high temperature, e.g. 200°C.

As the furnace heats up, check that the temperature display of the controller increases.

If it decreases initially, but soon increases again, everything is probably OK: The temporary decrease may have been caused by the cooling water, cooling the furnace below room temperature prior to heating.

If the temperature continues to decrease towards and beyond the freezing point, the thermocouple has been installed in the reverse way, or the wiring onwards to the controller is incorrect. **Immediately stop the heating** as you are in danger of overheating and destroying the furnace, your sample and possibly the cell. Do this by switching the power off or some other safe measure. **Simply setting the controller to a low temperature may not be sufficient:** It will continue to give full power, since it believes the temperature is very low and is decreasing. Identify and correct the error and try again.

If the temperature does not change at all or increases much less than you expect, **stop the heating** as above. Check whether the furnace has indeed become heated (if necessary by retracting the cell or removing the cap of the furnace tube and testing by e.g. a thermometer). If not, check the furnace, power supply, and controller operation. If, on the other hand, the furnace and cell have become heated, the thermocouple may have been short-circuited inside the cell (in which case the apparent temperature may increase only a little) or outside, in the wiring. Alternatively, what you believed was a thermocouple may instead have been two equal wires. Identify and correct the error. If the system seems OK, check whether the controller is really set to the type of thermocouple you are using. (The cells are equipped with type S (Pt-Pt10Rh) as standard.) You may also have to check the calibration of the controller. If this also seems OK, try to confirm that the thermocouple installed is indeed of the expected type. As part of the checking procedures, measure the voltage of the thermocouple manually with the voltmeter, and estimate the temperature (see below) as compared to what the controller says.

If the temperature controller responds reasonably, let the cell stabilise at 200°C or higher.

In order to check the controller, let the furnace stabilise at a typical operating temperature and measure the voltage over the controlling thermocouple. You may do this by connecting to it in parallel with the

controller at some available connection, or by very temporarily disconnecting the controller. Calculate the temperature, compensating for room temperature, by using a thermocouple table: First read room temperature voltage out of the table, add it to the measured voltage, and read the temperature from the table using the corrected voltage. It should correspond to the controller's display $\pm 1^\circ\text{C}$. If the deviation is significant, check your measurements, calculations and eventually your controller's settings and calibration.

7.2.3 Centre of the hot zone

When the controller has been checked, let the cell stabilise at a temperature in the middle of the desired operating range, say 800°C . Record the temperatures of the thermocouples (using appropriate room temperature correction) and, if possible, the open circuit voltage over a sample. This voltage is normally given by the thermoelectric power of the sample, and its absolute value will in that case roughly be proportional to the temperature gradient over the sample.

If the sample is below the centre of the hot zone, the inner/bottom thermocouple will typically be cold relative to the central and upper thermocouples, and vice versa.

Next, move the cell 2 cm upwards or downwards. If you are moving towards the centre of the hot zone, the temperature gradient through the cell expressed through the thermocouples will become less, and the absolute voltage over the sample will decrease. Move in one direction or the other until the centre point is found to, say, 1 cm. Write this position down.

If there is discrepancy between the thermovoltage of the sample and the thermocouples with respect to decision of position of centre of hot zone, the reason may be that the sample is a partly ionic conductor and that the gases on both sides are not the same: In that case supply a simple and well-defined gas, e.g. wet air, on both sides. Alternatively, you may have surpassed the accuracy of the thermocouples.

Now, either repeat the procedure for a range of temperatures so as to obtain a position for each.

Alternatively, leave the cell at the obtained position, go to other temperatures and record the temperatures above and below the sample, and possibly the thermovoltage, and make yourself a report and plot of temperature gradients over the sample vs. temperature.

The goodness of the isothermal zone varies with temperature and furnace design. You can improve it by inserting thermal shields to protect "cold-radiation", especially in the central support tube, of the same type as you would use to protect the cold parts from heat radiation.

Based on these measurements you should be able to judge also the quality of your thermocouples. Their being equal is particularly important if you are going to do Seebeck coefficient measurements. For most purposes you may expect that un-calibrated thermocouples are correct to within $\pm 1^\circ\text{C}$, while for Seebeck coefficient measurements you may want to take special measures (e.g. calibration) if you intend to use small temperature gradients and still expect accurate data.

7.2.4 Temperature profile

In some cases it is of interest to establish the temperature profile over larger distances in the cell. This may be part of an initial mapping of the cell and furnace behaviour. Or it may concern measurements of permeability or other properties in the case that a closed tube of the sample material replaces the support tube, so that transport takes place in the entire tube. Finally, it may be of interest if you need to calculate the kinetics and stability in the gas phase (e.g. with respect to carbon precipitation from $\text{CO}+\text{CO}_2$ mixtures).

For this you need in general to place the control thermocouple at a fixed position and insert the cell at a fixed height, and then measure the temperature at one or two other thermocouples after stabilisation. Then the cell must be cooled and retracted, the position of the non-controlling thermocouples changed and the temperatures measured again in the same manner. It is possible to retract and reinsert the cell directly from a (not too) hot furnace to speed up the process, although there is a certain risk that an outer tube of

alumina cracks (use silica instead?). Remember to switch off power while the cell is out if the TCC is used to control the furnace.

If the non-controlling thermocouples are to be moved much, it may be wise to use versions with less insulation tubes.

7.3 Gas tightness

Before applying toxic or flammable gases you should ensure that the assembled cell is gas tight. This is also important if you want to control the atmosphere by applying pure gases, accurately mixed buffers, sub-atmospheric pressures or vacuum.

The cell is not designed as high-vacuum equipment. It is primarily designed to work at atmospheric or slightly higher than atmospheric pressures.

7.3.1 Checking gas tightness using slight overpressure.

This procedure is suitable for checking both the total cell gas tightness and the tightness between the cell chambers in cases where these have been sealed off from each other.

Connect a gas flow to an inlet of the cell with a T-connection to an overpressure controller of e.g. 20 cm column of mineral oil, followed by a flowmeter (e.g. a rotameter with fine scale). Allow gas to flow to the cell. Close the cell outlet(s) if not done already. The flow in the flowmeter should now go to zero, as a first check. If it remains at a stable non-zero flow, there is a large leakage. This may often be spotted by using soap water (or the commercial “Snoop”) at suspected leaks.

If the flowmeter does go to zero, there may still be small leaks below the detection limit of the flowmeter. Check this by stopping the gas flow to the system (before the overpressure stage). The bubbling in the overpressure stage stops. If the apparatus is gas-tight the column remains at the full height. If not, the overpressure and the column height decrease. The column should be stable for an hour or more.

7.3.2 Checking gas tightness using vacuum

If you have a vacuum pump and a pressure gauge, try to pump down the cell through one of the gas connects. Preferably, the pressure should be read on one of the other connects, but a reading on the pumping line is acceptable. If you have a cell with connects with shut-off valves built in, it is sufficient to leave these unconnected; connect the pump and gauge on the two other (usually the outlet connects).

The vacuum reached is an indication of the gas tightness, but a poor reading initially may also reflect degassing.

For version A-2 cells you should typically read 1 mbar if monitoring on another connect than the one you are pumping on. You should reach typically 0.1 mbar if monitoring on the pumping line.

For versions A-3 and later you should typically reach 0.1 and 0.01 mbar under the same conditions.

A more sensitive test is to monitor to which degree the vacuum remains after the pump has been disconnected. The pressure should not raise more than 1 mbar per minute for A-2 cells, or 0.01 mbar per minute for A-3 (and later) cells.

If the system leaks, you may check with e.g. a mass spectrometer tuned to a special gas, or monitor the total pressure during pumping and with addition of light or heavy components to spots of suspected leakage.

With the transport enclosing tube installed, you may also immerse the whole cell in water while applying slight overpressure to it (e.g. by blowing into a gas line connected to the cell). Bubbles will reveal coarse leakage points, but probably not finer ones.

7.3.3 Sources of leakage

The most probable sources of gas leakage in the ProboStat are:

The enclosing tube O-ring seal:

The remedy is first to tighten the flange a little more. If necessary open it and inspect the O-ring for cracks or wear. Clean and slightly grease the surfaces. You may need to use an O-ring of slightly different dimensions (smaller and/or thicker) if the tube is too small.

The electrical feedthroughs:

These are mechanically sealed. If they become loose due to damage, they may leak, and sealing with grease or permanent replacement may become necessary. However, we suggest you do not glue them, as that will make replacement difficult.

Cracks in the enclosing tube:

Replace it.

If you are not able to locate a leakage by other means it may be possible to take a cell subjected to slight overpressure and submerge it fully or partially in water; a major leak will usually easily be seen by the emerging bubbles.

Leakages between the cell chambers are usually found in the sample seal itself or in the sealed sample not being 100% gas-tight due to porosity or cracks. Check also that the support tube O-ring below the support tube ring is intact.

8 Methods and measurements

Use tables and figures in Ch. 4 to identify where on the base unit the various connections should be made and where the measurement leads emerge and also to identify thermocouples and electrode contacts when necessary.

For some methods, there are schematic illustrations of what parts to mount and where and how to connect and use them. In these, the main idea is that the scheme going from left to right illustrates how the cell is assembled from inside (at the pedestal) and outwards, as well as upwards.

The number of such schemes will be increased in future updates of the manual. Let us know if you need a particular scheme, and we will try to prioritize that one, send it to you, and include it in manual updates.

8.1 Temperature measurements

Up to four thermocouples are supplied with ProboStat. You may use from one to three of these simultaneously:

For temperature control and general temperature reading, use the **control thermocouple TCC**. It comes in two lengths: **TCC/D for disk samples** and TCC/B for bar samples. Connect it via a compensation cable to your temperature controller or readout unit. Align it at the side of the sample. Cap it if possible.

For measurement of the temperature under a disk sample, use the inner thermocouple TCI. (In ProboStat versions A-1 and later this is identical with the TCC/B). **Cap it if possible.**

For measurements of the temperature at the bottom of a bar sample (in Seebeck measurements) use the bottom thermocouple TCB. Position the tip of thermocouple as wanted or contact sample as described under section on Seebeck coefficient measurements.

For measurements of the temperature at the top of a sample, use the top thermocouple TCT. Position the tip of thermocouple as wanted or contact sample as described under section on Seebeck coefficient measurements.

For readout units with internal room-temperature compensation, or with reference junction in ice/water at 0°C, use compensation cable all the way from ProboStat. If such compensations or references are not available, one may or may not use compensation cables: The reading must be adjusted manually by the temperature at the point of transition from Pt/Pt10Rh or compensation cable to ordinary (copper) wiring: Measure the voltage of the thermocouple. Read the temperature at the Pt/Pt10Rh to copper junction. Read the thermocouple voltage for that temperature from a table. Add this voltage to the measured voltage. Use the sum to find the temperature from the table.

8.2 Conductivity and impedance measurements

8.2.1 General

Important: Many 4-terminal impedance spectrometers require the shields of the current terminals to be connected to each other, preferably close to the sample. The standard way of doing this in ProboStat is by help of the **Shields Bridge Switch** (to the Down position) or (for older cells without this switch) by installing **the shields bridge** wire at the feedthroughs of the base unit. This connects the shields of the current leads and also includes the shields of the voltage leads.

8.2.2 2-point impedance spectroscopy and conductivity measurements on disk sample

8.2.2.1 General

2-point measurements are preferable for samples with moderate or small conductivities, for doing impedance spectroscopy in search of characteristics dominated by capacitive elements, and for crystals so small that 4-point measurements are difficult.

If you have a 4-terminal measuring device, ProboStat utilises 4 leads also for two-point measurements, and the lead resistance is then eliminated. However, the spreading resistance of the electrode remains and cannot be delineated easily, and it thus sets a limit for the method on the low-impedance side.

8.2.2.2 Sample

The sample is typically a sintered disk or a cut crystal slab. Although the net electrode contacts supplied with ProboStat may provide current collection, it would normally be required that each sample face is equipped with a painted electrode or a net sintered to or into the surface, or both.

If you plan to do concentration cell emf transport number measurements with the same sample, apply an electrode, which is limited to the inner area of the support that the sample will rest on. This prevents that the rim of the inner electrode experiences the atmosphere on the outside. Thus, for a 20 mm disk on the 20 mm support, you may use for instance a 10 mm diameter electrode. Normally you then let the outer electrode have the same dimensions as the inner. If you are not going to do concentration cell measurements the electrodes may well cover the entire face of the sample.

See also below for surface guard electrode.

If you use painted electrodes, and the sample will attain a reasonably high conductivity it is essential that the painted electrode conducts well. We suggest that a painted and fired Pt electrode should give less than 0.5 ohm when contacted by the probe tips of a multimeter 1 cm apart. If it doesn't you may want to apply more layers of paint.

Be sure to measure the sample's thickness and the area of the two electrodes before assembly.

8.2.2.3 Assembly

In the simplest setup you may use two H2N# "hand" electrode contacts to contact the electrode.

Connect the two electrode contacts from the lower sample electrode to LC (low current, feedthrough 6) and LV (low voltage, feedthrough 8). Connect the two electrode contacts from the upper sample electrode to HV (high voltage, feedthrough 13) and HC (high current, feedthrough 15).

Control temperature by the TCC/D thermocouple. Monitoring of temperature below sample using TCI is optional. For controlled atmosphere supply gas to the outer chamber. Supply to the inner chamber (or only extraction through the inner chamber outlet) is optional, but helps complete gas exchange.

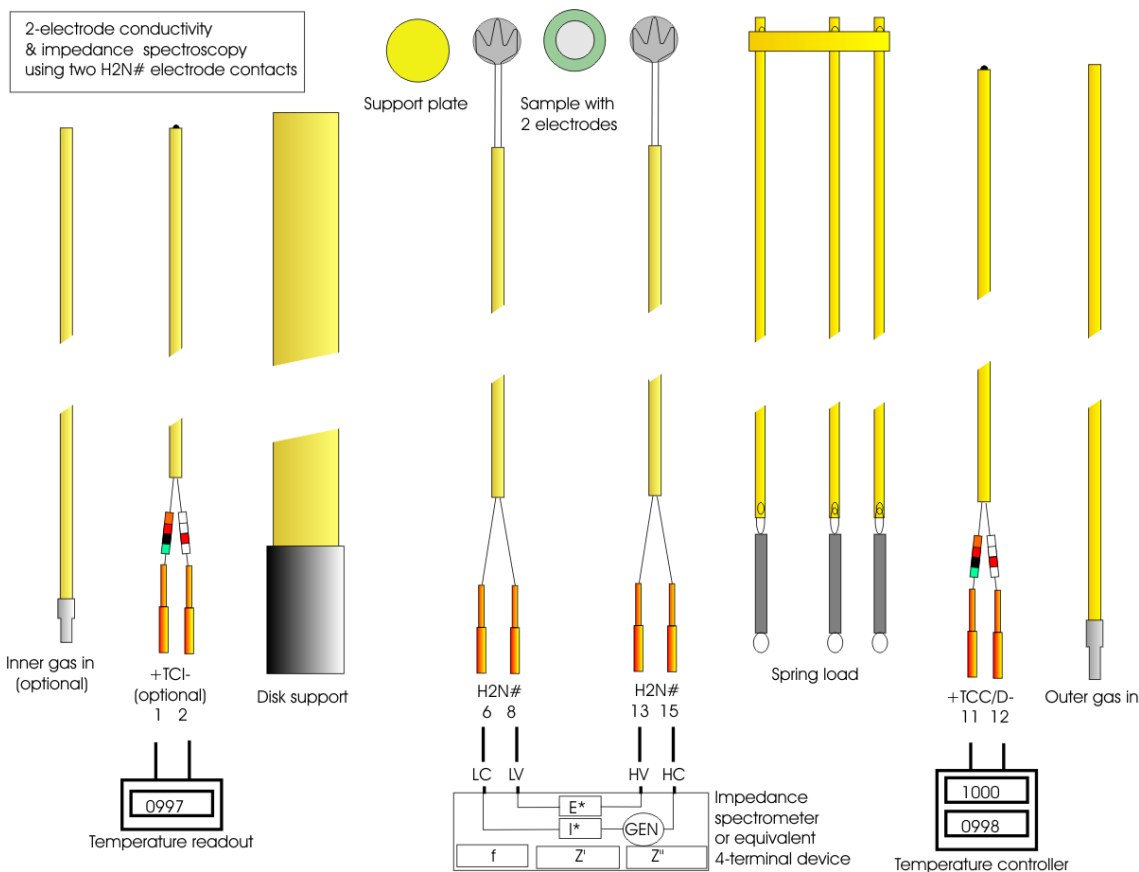

Figure 8-1: Schematic assembly of 2-point conductivity or impedance spectroscopy measurements using disk sample with 2 electrodes, contacted by 2 H2N# electrode contacts. Optional inner thermocouple TCI and optional support plate.

Alternatively, you may use two GP2N# nets contacted via two GP2 (or four GP1). For such assemblies, use any disk sample support tube, normally with a support plate (with or without centre hole) on top.



Figure 8-2: Support disk on support tube, with GP2N# as electrode connected by two GP1. This forms the lower electrode; the sample and another GP2N# are to be placed over it. Also showing outer gas supply tube (left) and control thermocouple TCC/D (right).

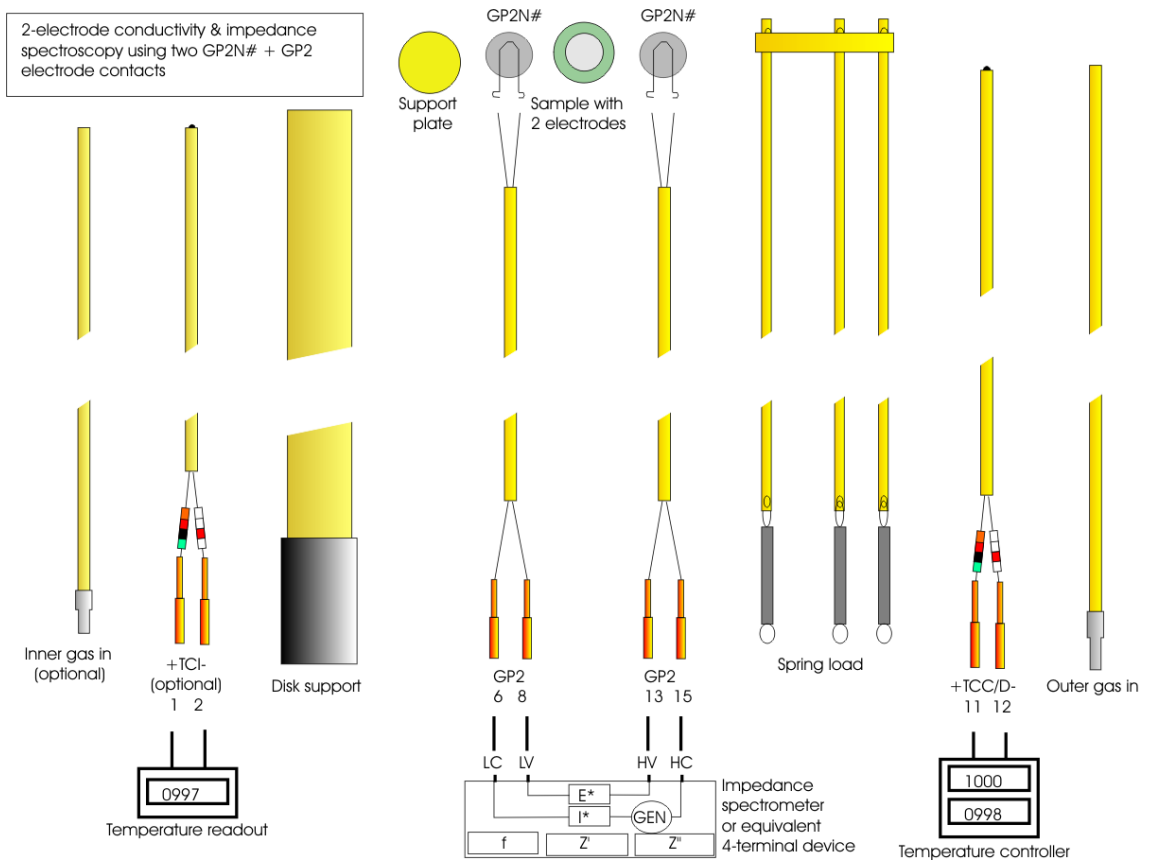

Figure 8-3: Schematic assembly of 2-point conductivity or impedance spectroscopy measurements using disk sample with 2 electrodes, contacted by 2 GP2N# nets using 2 GP2 electrode contacts. Inner thermocouple TCI and inner gas supply tube are optional.

Instead of using a support plate and an outer electrode connection for the lower electrode, you may instead use the inner electrode contact for the lower electrode. The latter is required if you want to do concentration cell emf measurements simultaneously or if you are applying a surface guard (see below).

In order to use inner electrode contacts to the lower electrode, do the following: If not already done, mount the inner gas supply tube using a silicone hose. **Adjust the thread of the hose onto the tube so that the tube appears to be perfectly aligned with the top of the sample support tube.** Check by actually mounting the sample support tube appropriately. Next, put the bent top of the inner electrode contact IN2 or INH2N12 into the top end of the central gas tube and connect it to ILC and ILV.

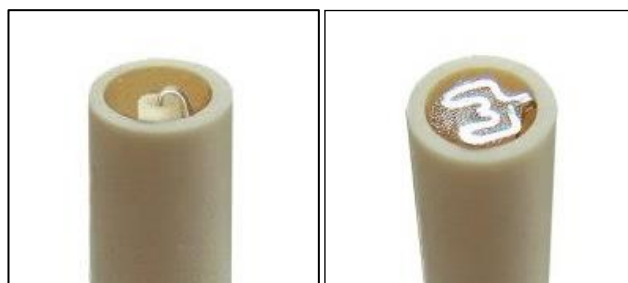

Figure 8-4: Left: Inner electrode contact IN2 in combination with thin (open) inner gas supply tube shown properly inserted in the gas supply tube and aligned 1/2 mm above the rim of the support tube. Right: INH2N12 in combination with multibore gas tube is used and adjusted similarly.

If the tube was properly aligned the half a millimetre of wire now just extends over the rim of the support tube. A sample or a dummy disk pressed against the support tube should then easily press the contact down against the force of the hose.

If your sample is smaller than your support tube, you may use the support plate with a centre hole. In this case the IN2 contact and the gas supply tube hose should be adjusted (extended) so that the contact extends $\frac{1}{2}$ mm over the hole in the support plate.

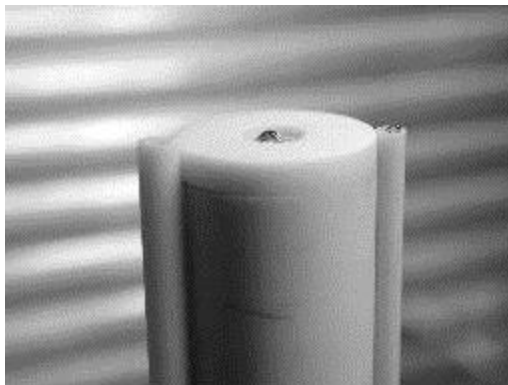

Figure 8-5: *Inner electrode contact IN2 extended through hole in small sample support plate*

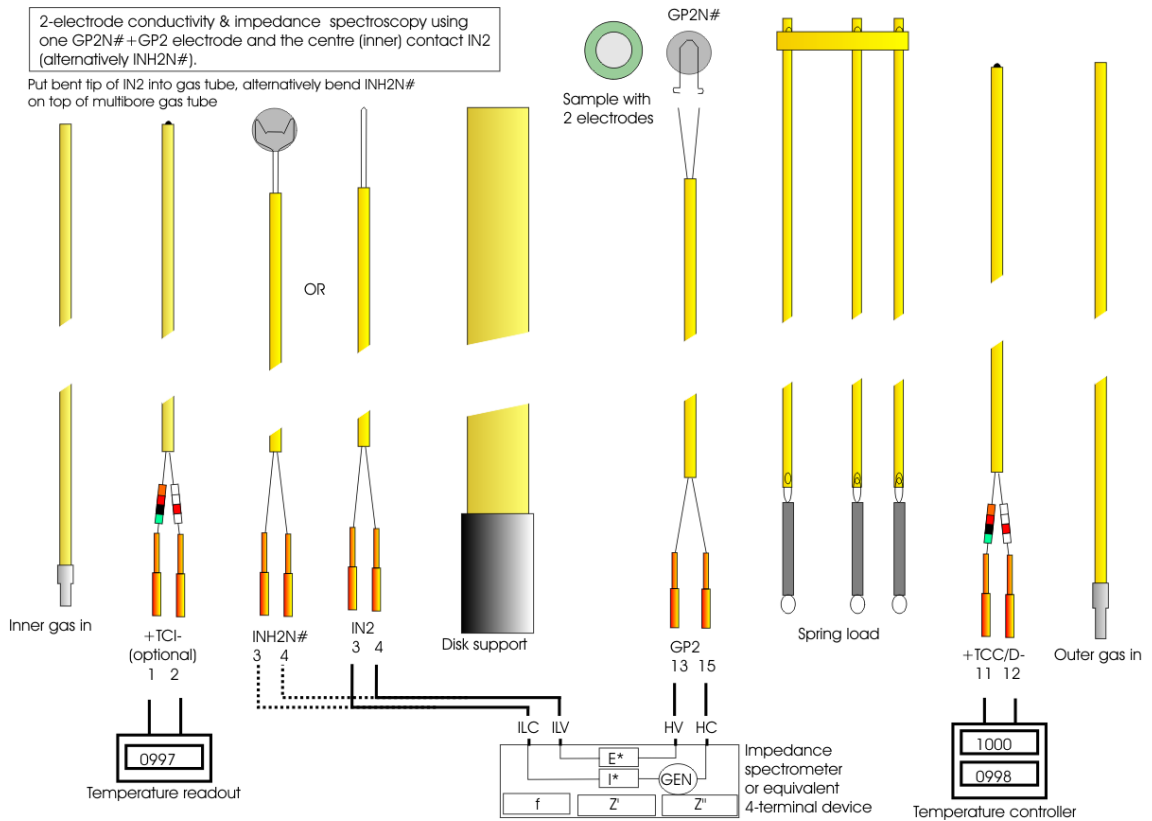

Figure 8-6: Schematic assembly of 2-point conductivity or impedance spectroscopy measurements using disk sample with 2 electrodes, contacted on the inside by an INH2N12 with multibore gas tube or an IN2 with a simple gas tube, using the compressed hose of the inner gas supply tube as spring force upwards. On the outside it is contacted by a GP2N net using a GP2 electrode contact. (An H2N# can be used instead). Inner thermocouple TCI is optional.

8.2.2.4 Measurements and interpretation

Measure conductivity or impedance characteristics using the HC, HV, LV and LC terminals. Alternatively, use the HC, HV, ILV and ILC terminals if using the inner electrode connections.

The result is an impedance Z or an admittance $Y = 1/Z$. In DC measurements these are given as resistance R (ohm) or conductance G (S) = $1/R$, respectively. In AC measurements and impedance spectroscopy they are complex numbers $Z^* = R + jX$ and $Y^* = G + jB$. AC instruments can provide these data in a number of formats. For disk samples it is most common and appropriate to get parallel conductance G or parallel resistance $R_p = 1/G$ and parallel capacitance $C_p = B/2\pi f$, where f is frequency. More about this can be found in a separate section on impedance spectroscopy later in this manual.

Since the method comprises two electrodes, the measurement contains impedances from the electrodes in addition to the sample volume

$$Z_{\text{measured}} = Z_{\text{volume}} + Z_{\text{electrode}}$$

In AC measurements, the electrode impedance may be short-circuited and thus eliminated from the measurements by the high capacitance of the electrodes at sufficiently high frequencies. 10 kHz is a typical frequency that may be used to achieve this, as long as the electrode impedance is not very high.

The volume impedance of a polycrystalline sample may have contributions from the impedance of highly resistive grain boundaries (across), so that

$$Z_{\text{measured}} = Z_{\text{volume}} + Z_{\text{electrode}} = Z_{\text{grain}} + Z_{\text{grain boundary}} + Z_{\text{electrode}}$$

Impedance spectroscopy should be used to fully and reliably separate the impedance into its different series contributions. This is explained in more detail in a separate section on impedance spectroscopy later in this manual.

The volume admittance (inverse of impedance) may have contributions from highly conductive grain boundaries (in parallel):

$$Y_{\text{volume}} = Y_{\text{grain}} + Y_{\text{grain boundary (parallel)}}$$

Parallel admittance by grain boundaries can *not* be deconvoluted using impedance spectroscopy. Usually the grain boundaries are considered either resistive or conductive, so that they contribute to the impedance or admittance, but not significantly to both.

8.2.2.5 Using geometrical factors to obtain specific conductivities and resistivities

Transform to specific properties conductivity σ or resistivity ρ by taking effective electrode area A and length d (here sample thickness) into account. The unit for conductance G is Siemens (S), and thus, when we use the unit cm for length, we have:

$$\sigma(S/cm) = G_{\text{measured}}(S) \frac{d(\text{cm})}{A(\text{cm}^2)} \quad \text{and} \quad \rho(\text{ohm} \cdot \text{cm}) = R_{\text{measured}}(\text{ohm}) \frac{A(\text{cm}^2)}{d(\text{cm})}.$$

Moreover, we have

$$\sigma = \frac{1}{\rho} \quad \text{and} \quad G = \frac{1}{R}.$$

It is useful also to note that conversion to/from SI units is done by

$$\sigma(S/m) = 100\sigma(S/cm) \quad \text{and} \quad \rho(\text{ohm} \cdot m) = \rho(\text{ohm} \cdot \text{cm}) / 100.$$

8.2.3 2-point conductivity measurements on disk sample with surface guard

8.2.3.1 General

A guard electrode contacts the ground system of the measuring device, and currents picked up through this electrode do not contribute in the conductivity measurement. The surface of disks may be connected in this way, and it is then possible to eliminate surface conduction from the overall conductivity of a highly resistive sample.

8.2.3.2 Sample

For surface-guarded measurements, the disk sample under-side should be equipped with a centre electrode smaller than the opening of the support and a ring electrode fitting the support. The upper electrode should match the centre electrode.

8.2.3.3 Assembly

Assemble the sample as described for ordinary 2-point measurements, using the inner electrode connections to contact the centre electrode. In addition, place the ring electrode contact on the rim of the support tube so as to contact the ring electrode on the sample. Connect the ring electrode contact to the LC feedthrough and use the LC lead as surface guard connection.

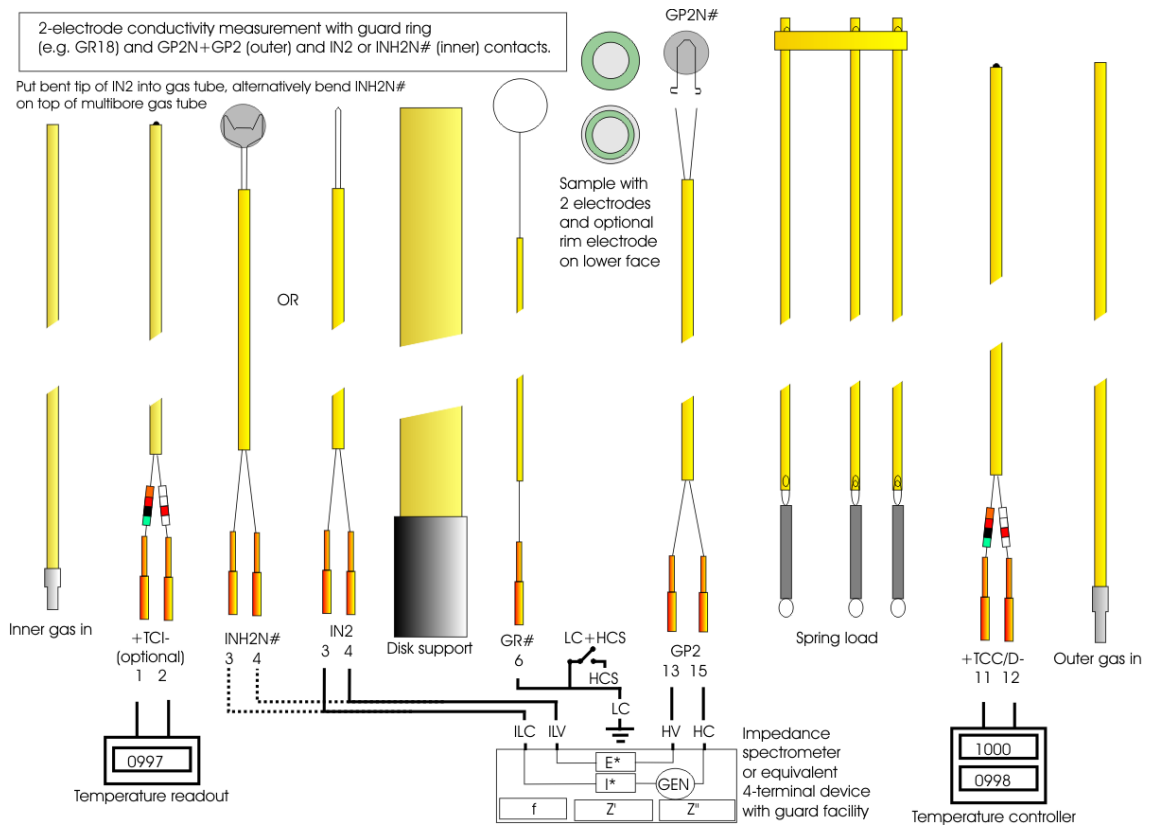

Figure 8-7: Schematic assembly of 2-point conductivity measurements with surface guard using disk sample with 2 electrodes (contacted on the inside by an INH2N12 or IN2 electrode contact and on the outside by a GP2N # net using a GP2 electrode contact). (An H2N12 can be used instead). The guard ring (e.g. GR18) contacts the rim of the sample. Ground the ring through the LC terminal or use the LC+HCS switch (see text for details).

Since the ring electrode contact lifts the sample ca. 0.5 mm above normal height, the gas tube pressing the inner electrode connections in contact with the centre electrode may need to be adjusted upwards 0.5 mm as well.

The guard function is activated by connecting the guard electrode to the guard terminal of the device, referring to its operating manual.

8.2.3.4 Measurements and interpretation

With the guard connected, the measured conductivity should always be lower than without the guard, since the guard steals some current also from volume conduction of the sample. However, as the volume conduction gets very small, e.g. at low temperatures, guarding may give a more pronounced decrease in observed conductivity, the difference being the surface conduction.

By measuring the conductivity under conditions where one may assume that surface conduction makes no significant contribution, with and without the guard, one may establish an effective geometric factor for the measurements with surface guard. Use this to calculate the conductivity also under other conditions. As you move towards a situation with significant surface conduction, the conductivity without the guard (using the normal geometric correction) will start getting higher than that with the guard (using the empirical factor). The difference is the surface conduction that adds to the unguarded measurement.

8.2.4 4-point conductivity measurements on bar sample

8.2.4.1 General

Bar sample 4-point measurements are suitable when you need to characterise a highly conducting material with a four point method and the sample is available as a bar.

8.2.4.2 Sample

The bar should be equipped with current collecting electrodes of Pt paste or equivalent at the ends to ensure that the current is well distributed through the sample cross-section. The voltage probes may e.g. be wrapped 1/3 and 2/3 length down the sample. It may be a good idea to saw small grooves at corners to keep wraps in place. Also, increasing the contact by application of a little Pt paint on the wraps is sometimes beneficial.

Be sure to measure the sample's dimensions between the voltage probes accurately before assembly.

8.2.4.3 Assembly

Use the bar sample support assembly. For control thermocouple, use the TCC/B.

Place the alumina "floor" plate at the bottom of the sample slit, put the sample on top, put the short alumina "roof" rod above, inside the support tube, and press it down using the standard triangular spring load assembly. Let the wrapped contacts from the sample stand out from the slit and contact them in the order of top to bottom to the HC-HV-LV-LC feedthroughs with general purpose contact wires (4 x GP1 or 2 x GP2), see Figure 8-8. You may do this e.g. by wrapping the thinner Pt wire around the thicker.

If the current electrodes at the sample ends are not done by wrapped wire, but by painted end faces or similar, you can use the single wire "hand" electrode contacts (H1TN10 and H1BN10) which are inserted between the sample and the floor and roof, respectively, see **Figure 8-9**.

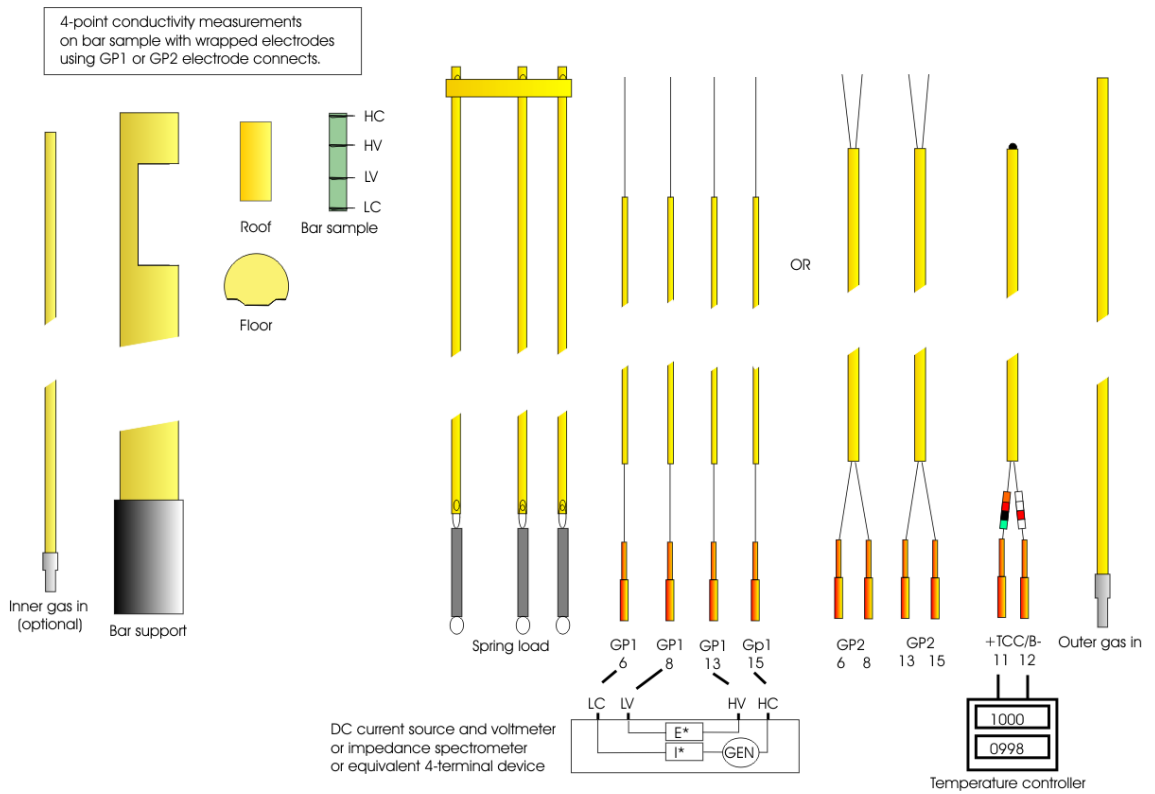

Figure 8-8. Example of assembly of 4-electrode conductivity measurements on bar sample, where sample has 4 pre-wrapped thin Pt belts. Use 4xGP1 or 2xGP2 and twist the thin belt ends into contact with each of the 4 electrodes contact wires.

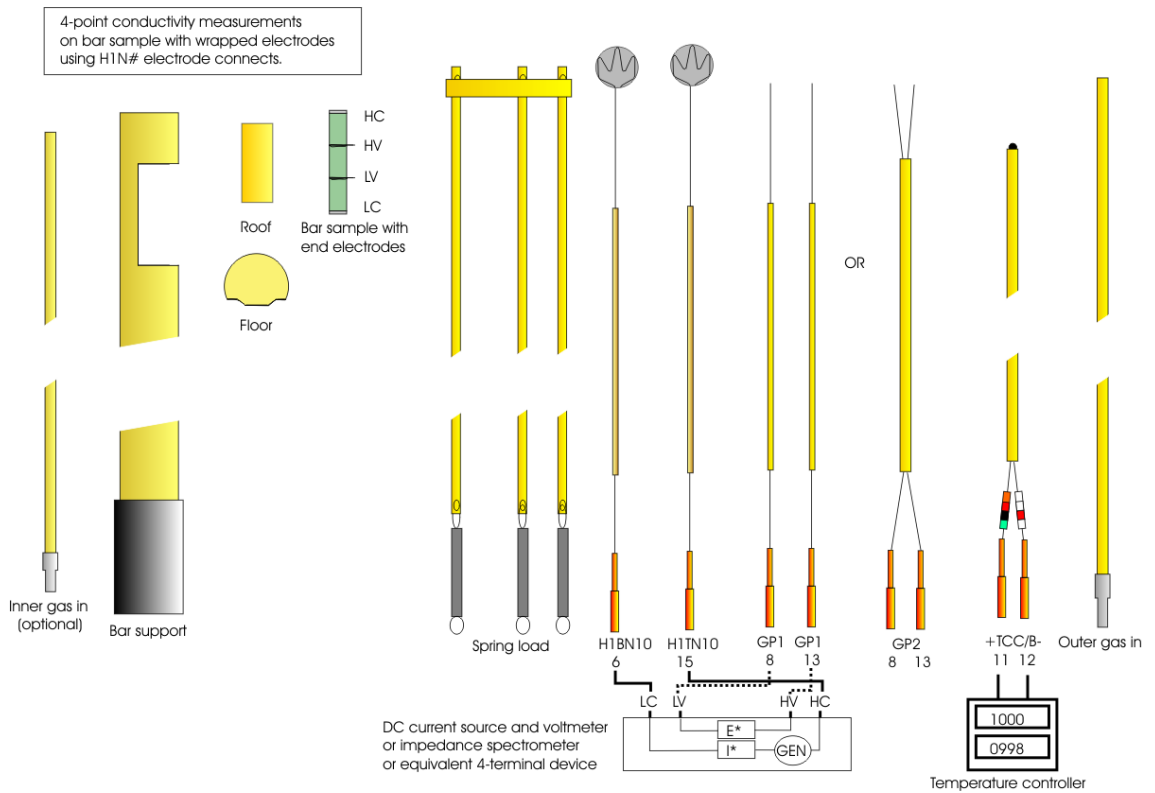

Figure 8-9. Example of assembly of 4-electrode conductivity measurements on bar sample, where sample has 2 pre-wrapped thin Pt belts and painted Pt electrodes at each end. Use 2xGP1 or 1xGP2 and twist the thin belt ends into contact with each of the 2 electrodes contact wires.

8.2.4.4 Measurements and interpretation

Measure the conductance using the HC-HV-LV-LC terminals and a four-terminal device. For specific properties the measured data must be corrected for the area and length between the voltage probes.

8.2.4.5 Special considerations

If the material is a mixed ionic - electronic conductor, the ionic current may be partly blocked by the contacts such that the total conductivity measured is too low. It may help to increase the applied voltage, since this may overcome the activation potential of the electrode reaction.

All in all, the result should be independent of applied voltage and frequency in a range around the conditions used.

It may be a good idea to apply a drop of e.g. Pt paint onto wrapped contacts before or after wrapping. Upon heating, the paint cures and creates a finite contact spot that will decrease the impedance of the contact. Some materials, e.g. chromium-containing oxides, may form insulating contacts with Pt, and it may be advisable to use e.g. gold contacts.

The technique is vulnerable to very highly resistive electrode contacts, often at reduced temperatures, and the measurements may eventually fail or give erroneous results.

For combined 4-point conductivity and Seebeck coefficient measurements, see the latter.

8.2.5 Van der Pauw 4-point conductivity measurements

8.2.5.1 General

Van der Pauw measurements are suitable whenever you need to characterise a highly conducting material with a four point method and the sample is readily available as a thin slab.

8.2.5.2 Sample

The sample must be a thin slab of arbitrary shape, preferably a circular disk of 20 mm diameter to utilise the size of the cell and as good as possible meet the requirements of the method, since the electrodes in principle should be placed far apart compared with the thickness of the slab.

Be sure to measure the thickness of the slab accurately before mounting it.

8.2.5.3 Assembly

Place the sample on top of a sample support tube. Use the van der Pauw assembly with two spring load alumina tubes and a bridge tube holding two contact tubes each with a pair of leads (VDP2). Connect one pair to the HC and HV feedthroughs and the other to the LV and LC feedthroughs. Place the contact tubes such that each electrode is pressed against the sample surface as close to the rim as practically possible, e.g. at 1 mm. It is not necessary that the contacts are placed symmetrically around the rim. It is essential, however that the order HC-HV-LV-LC follows the rim around in one direction (or that you at least know the order).

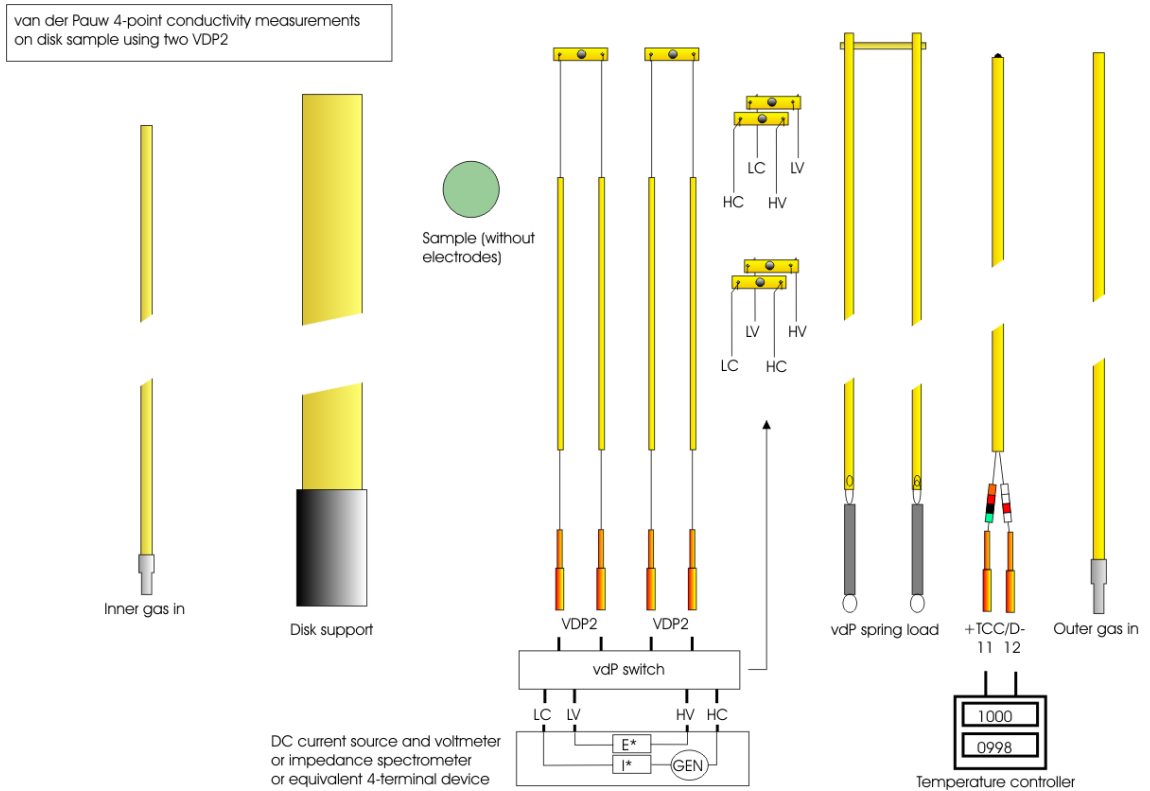

Figure 8-10. Assembly of van der Pauw 4-electrode measurements.

8.2.5.4 Measurements and interpretation

Measure the resistance (R_1) using the HC-HV-LV-LC terminals and a four-terminal device. Then, circulate all terminals one-step manually on the device or via a switch so that for instance HC becomes HV, HV becomes LV, LV becomes LC, and LC becomes HC. Measure the resistance again (R_2). The van der Pauw equation relates the two measured resistances, the sample thickness d and the specific resistivity ρ of the sample material:

$$\exp(-\pi d R_1 / \rho) + \exp(-\pi d R_2 / \rho) = 1$$

Solve the equation numerically to obtain the resistivity ρ .

If the thickness is not known at the time of measurement, one may obtain ρ/d instead (unit ohm) and get ρ later by multiplying with the thickness d .

8.2.5.5 Special considerations

If the sample is small you may relocate the electrodes at the contact tubes by re-wrapping them into the inner set of holes. However, be aware that it will be increasingly difficult to meet the requirements of an ideal van der Pauw geometry, and that calibration of your particular geometry with a known standard may be necessary.

The theory of the van der Pauw technique is valid for DC resistances, and if using AC instrumentation, it is necessary to ensure that the frequencies used are such that the imaginary part of the impedance is negligible.

If the material is a mixed ionic - electronic conductor, the ionic current may be partly blocked by the contacts such that the total conductivity measured is too low. It may help to increase the applied voltage, since this may overcome the activation potential of the electrode reaction.

All in all, the result should be independent of applied voltage and frequency in a range around the conditions used.

An impedance spectrum of a van der Pauw cell contains usually only the sample impedance, without any capacitance, but with a high inductance, due to the current running in the thin sample cross-section. Measurements at a single frequency are thus normally sufficient, and one might prefer a low frequency to avoid the inductance (and a high oscillator voltage to have a good signal-to-noise-ratio).

The technique is vulnerable to highly resistive electrode contacts, often encountered at reduced temperatures. A good check of proper functioning of the sample and setup is to ensure that the two resistances are of comparable magnitude; their ratio should only reflect the non-symmetry of the electrode placement. If they get largely unequal, there is probably a contact problem, electrode loss or sample breakage.

Some materials, e.g. chromium-containing oxides, may form insulating contacts with Pt, and it may be advisable to use e.g. gold contacts.

If any of the resistances measured are negative, there may be a mix-up of electrodes, or one or more of the electrodes are too resistive or out of contact. Alternatively, if you work with an AC instrument, it is also possible that the frequency may be too high and the inductance excessively high.

8.2.5.6 Checks and calibration

Check that the two measured resistances are both positive and reasonably similar in magnitude. If you apply AC instrumentation, check that each resistance is independent of frequency around the frequency you use.

The method requires no calibration in principle. However, the fact that your sample may not be very thin and that you are probably not able to place the electrodes exactly at the rim may suggest that you will get a small error in the measurement. This may be corrected for e.g. by attempting to place the electrodes in a similar way on a foil of a material with known conductivity and thickness. The measurement may then establish a correction factor for subsequent use with other samples.

8.2.5.7 Suggestions

It may be a good idea to apply a drop of e.g. Pt paint onto the contacts before or after pressing them onto the sample surface. Upon heating, the paint cures and creates a finite contact spot that will decrease the impedance of the contact.

In principle, the ratio between the two resistances and also between any of them and the sample resistivity should remain constant, so that one might measure this once properly and thereafter use only one measurement and the determined factor.

The van der Pauw technique may be combined with an emf-type transport number measurement by contacting the underside of the sample with the inner electrode contact, establishing a partial pressure gradient, and measuring the emf between any or all of the van der Pauw contacts and the inner electrode. Be sure to disconnect the inner electrode fully before doing the van der Pauw conductivity measurements. The combination may be useful in a screening, but is hardly optimal for any of the two methods.

8.2.6 Electrode impedance studies on disk sample with ring reference electrode

8.2.6.1 General

The reference electrode system in ProboStat comprises mainly the same parts and connections as were described for the surface guard. The reference electrode is placed as a ring on the sample's under-side resting on the support tube. The working electrode (under study) may be the top electrode or the bottom (centre) electrode, or both, alternatingly.

8.2.6.2 Sample

The sample should be a thick disk of electrolyte, with the electrode under study applied as a centre electrode, the counter electrode placed symmetrically on the opposite face, and a reference electrode placed as a ring outside one or the other.

8.2.6.3 Assembly

Connect the centre electrode with an electrode contact INH2N12 (in case of using a multibore gas tube) or IN2 (in case of a simple gas tube) to ILV and ILC, pressed up with the gas tube as explained before. Place the sample with the reference ring contacted by the ring electrode contact on the rim of the support. Connect this to the LV feedthrough. Connect the upper electrode, using a desired type of contact (GP2N# or H2N# or H2) to the HC and HV feedthroughs.

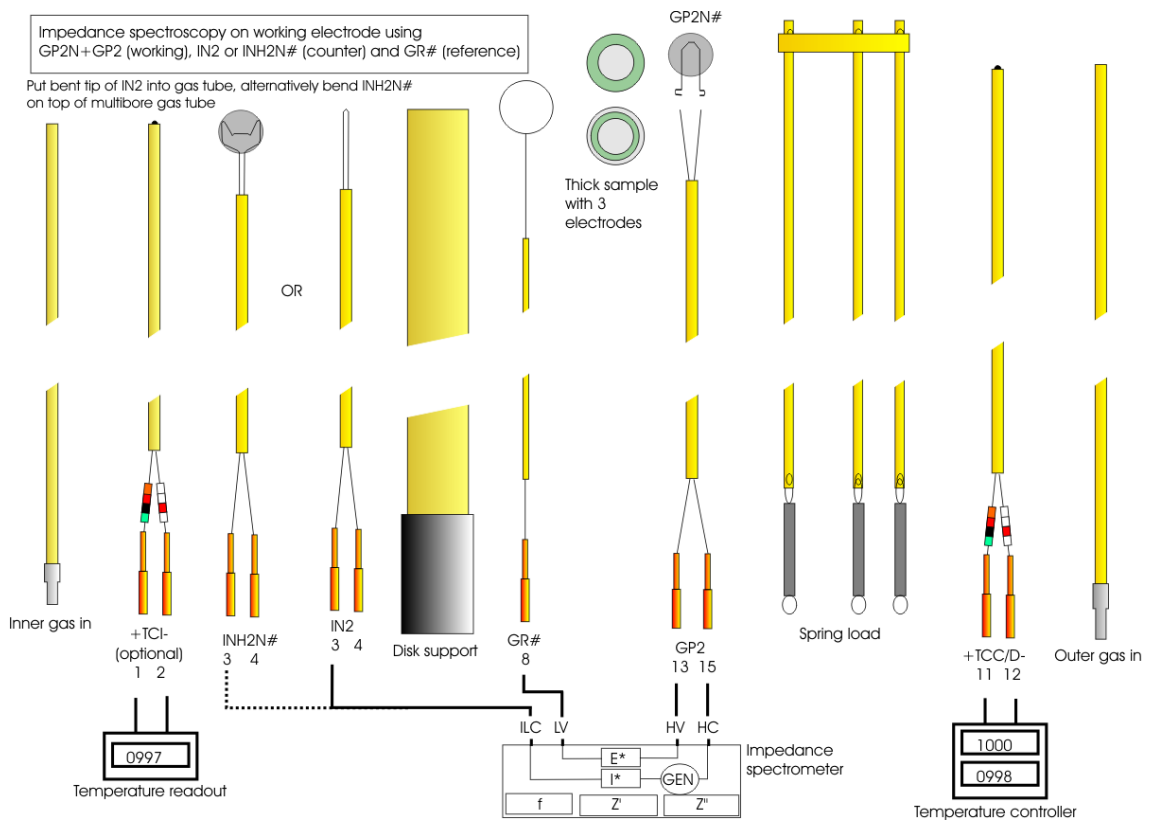

Figure 8-11: Schematic assembly of a 3-electrode setup for impedance spectroscopy of a working electrode, using the guard ring (e.g. GR18) as reference electrode contact. The counter electrode is contacted with INH2N12 or IN2 (using one lead only) and the working electrode with a GP2N# net using a GP2 electrode contact. (A H2N# can be used instead). As an alternative, the inner electrode may be measured as the working electrode by using both ILC and ILV while the upper electrode instead is contacted by only HC.

The setup is primarily designed for so-called symmetrical cells, i.e. cells with the same atmosphere on both sides of the electrolyte, since the reference electrode is placed between the inner and outer atmospheres.

8.2.6.4 Measurements and interpretations

A measurement of the impedance of the upper electrode is done by using the HC-HV-LV(ref)-ILC terminals.

A measurement of the impedance of the inner, centre electrode is done by using the HC-LV(ref)-ILV-ILC terminals.

The impedance measured consists of the electrode impedance of the working electrode and part of the electrolyte resistance. These are deconvolutable by impedance spectroscopy.

The impedance is the slope of the voltage-vs.-current-curve. If there is a DC bias superimposed on a small AC signal, the AC response should be representative of the slope of the curve at the point of the bias. If the bias is zero (zero current, open circuit) the electrode resistance may contain the charge transfer resistance (related to the exchange current). If there is a significant bias in either direction, the resistance may instead reflect Butler-Volmer-type deviations from linearity. In any case, the AC voltage should be small compared to thermal energy (kT) and to the bias applied. Ideally one would use 10-20 mV, but in practice one can use 20-50 mV at high temperatures as a compromise giving reasonably linear conditions and small noise levels.

8.2.6.5 Special considerations

Many alternative configurations may be set up by the user by applying electrodes in different ways to samples, and then connecting these using the general purpose wires.

Both in the ProboStat configuration and other disk designs, it is appropriate to warn against the use of too thin electrolytes, for which the current distribution of the working electrode and the potential of the reference electrode may be way out of control.

An alternative setup, what we may refer to as the Risø design, is designed to meet the problem of ensuring current distribution and true reference electrode functionality. This originates from Risø National Laboratories, Denmark. It comprises an electrolyte button where the working electrode is placed on top, where the reference electrode is drilled up into the centre of the button from below, and where the counter electrode is placed as a ring on the lower face. This geometry and configuration can well be fitted to the ProboStat 20 mm or 12 mm sample support tubes. In this case, the inner centre electrode contacts are used as reference (utilising the compressed hose force) and the ring electrode contact on the support rim is used as counter electrode. However, this requires a specially machined electrolyte and electrode contact leads (except the ring electrode) adjusted to other lengths. These are at present not delivered as standard parts with ProboStat.

8.2.7 Voltammetry studies on disk sample with ring reference electrode

8.2.7.1 General

This describes mainly the same setup as for impedance spectroscopy of an electrode, but now using a galvanostat/potentiostat for doing DC voltammetry and/or for interfacing the impedance spectrometer to the sample in a more powerful way.

8.2.7.2 Sample

As for impedance spectroscopy.

8.2.7.3 Assembly

Connect the inner electrode with the electrode contact INH2N12 or IN2 pressed up with the gas tube as explained before. Place the sample with the reference ring contacted by the ring electrode contact GR# on the rim of the sample support tube. Connect this to the LV feedthrough and onwards to the Reference terminal of the galvanostat/potentiostat. Connect the upper electrode, using a desired type of electrode contact (GP2N# + GP2 or H2N#) to the HC and HV feedthroughs. Connect the inner electrode contact to the Counter electrode terminal and the outer - to the Working electrode terminal or vice versa.

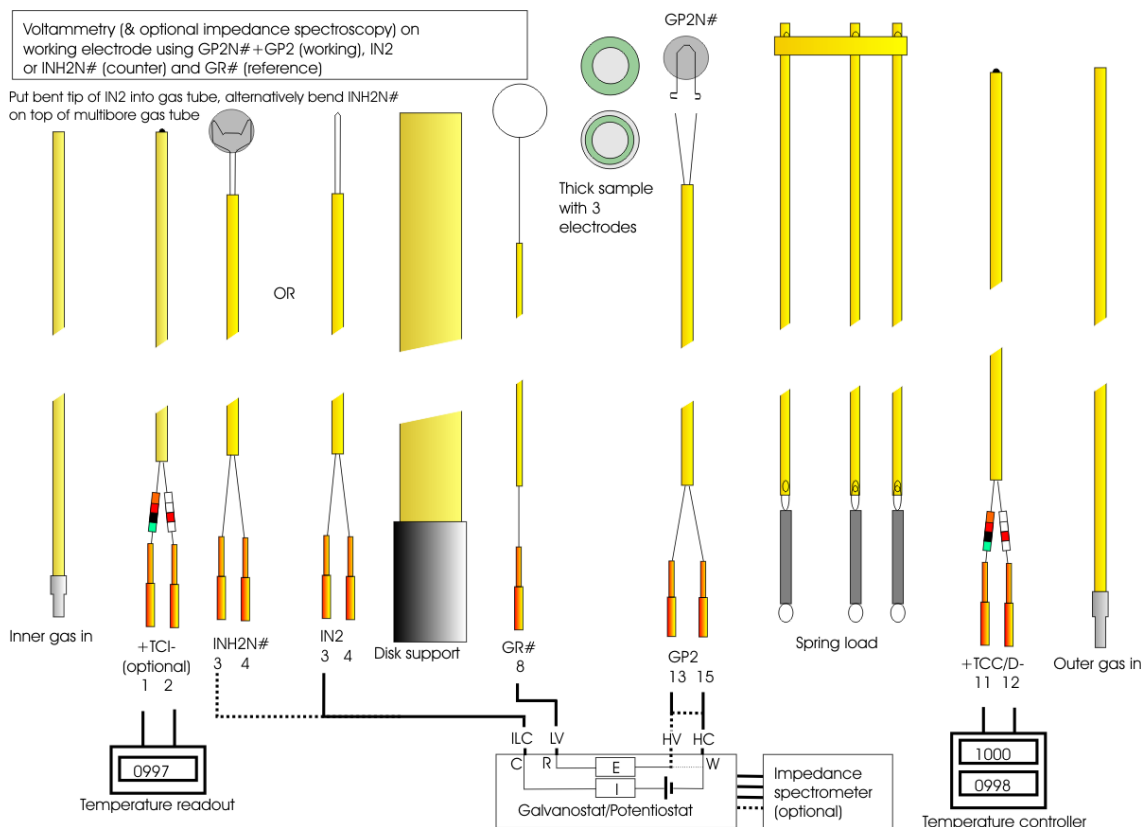

Figure 8-12. Schematic assembly of a 3-electrode setup for voltammetry (and impedance spectroscopy through the galvanostat/potentiostat) on a working electrode, using the guard ring (e.g. GR18) as reference electrode contact. The inner electrode is contacted with INH2N12 or IN2 (using one lead only). The outer can be contacted by any electrode contact type, here shown a GP2N# + GP2 using both wires to reduce ohmic loss. The inner and outer electrode may be swapped as counter and working electrodes.

If the galvanostat/potentiostat has two reference electrodes you may divide the HC and HV wires as for other four terminal devices and in this way alleviate the ohmic resistance of the wires to the working electrode.

The setup shown is primarily designed for so-called symmetrical cells, i.e. cells with the same atmosphere on both sides of the electrolyte, since the reference electrode is placed between the inner and outer atmospheres.

If large currents are to be drawn or supplied, a bent quartz gas supply tube to the upper electrode may help reduce mass transport limitations at this electrode.

8.2.7.4 Measurements and interpretations

The voltage-current curve represents the electrode impedance of the working electrode and part of the electrolyte resistance. These can be deconvoluted by impedance spectroscopy.

After subtraction of the electrolyte contribution to the voltage, the remaining voltage is in principle the overvoltage of the electrode. Plot it vs current to obtain the charge transfer resistance and the activation overvoltage, or vs log current to obtain the Tafel slope and to look for mass transport-related limiting currents.

8.2.7.5 Special considerations

Many alternative configurations may be set up by the user by applying electrodes in different ways to samples, and then connecting these using the general purpose wires.

See the previous parts on impedance spectroscopy for warnings and remedies concerning too thin electrolytes, improper use of reference electrodes, etc.

8.2.8 Asymmetrical sealed cell with reference electrode

8.2.8.1 General

In an asymmetrical cell, there is a seal between the sample and the support tube, which separates two atmospheres. A reference electrode can now *not* be placed at the top of the support tube, for two reasons: It would interfere with the seal, and it would in any case (e.g. if the reference ring was used as a seal itself) be placed between the two atmospheres and thus not be at a well-defined chemical potential. The reference electrode must therefore be placed elsewhere.

There are in disagreements between scientists as to whether there is any point of using a reference electrode in an asymmetrical cell – it is claimed that all information about one electrode from such a setup could equally well have been obtained from a symmetrical cell.

Moreover, asymmetrical cells are often made thin in order to yield a certain current. It is shown that this greatly reduces the possibility to obtain overpotentials and impedances that can be reliably assigned to only one (the working) electrode: A good 3-electrode measurement requires a thick electrolyte so that the electrolyte thickness is larger than the inevitable misalignment between working and counter electrodes.

We will leave these discussions out and describe how to set up a reference electrode with a sealed asymmetrical disk sample in the ProboStat. Two types of reference electrodes will be described for this case; ring and side reference electrodes.

8.2.8.2 Samples for asymmetrical sealed setups with reference electrodes

The sample should be a disk – preferably thick - of electrolyte, with the electrode under study applied as a centre electrode, and the counter electrode placed symmetrically on the opposite face.

The sample can have a **ring reference electrode** placed outside one or the other electrode, as used for symmetrical cells.

Alternatively, a **side reference electrode** can be made so that it extends to one side of the sample. See figure for examples. Note that ideally the working “centre” and counter electrodes should have the same shape and map each other as good as possible.

Depending on the details of how you set up the contacts, it may be necessary to pre-paste thin electrode contact wires to the electrodes. In both setups, the shapes of the electrode contacts may need to be adjusted from the standard shapes delivered with ProboStat packages intended for symmetrical reference electrode setups.

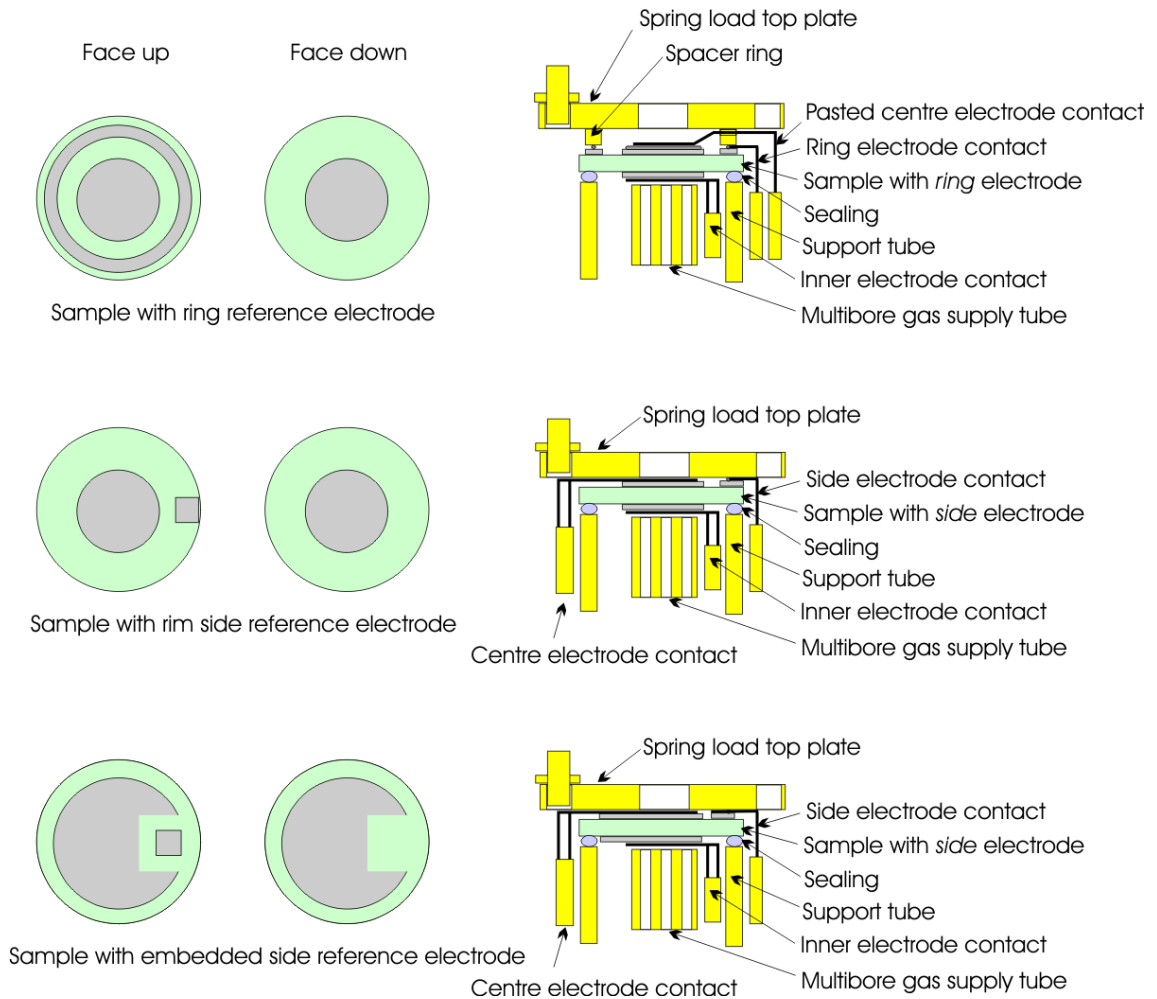

Figure 8-13. Three ways of applying reference electrodes, and how they may be contacted in a sealed asymmetrical cell.

8.2.8.3 Assembly of asymmetrical sealed setups with reference electrodes

Place the sample with the reference electrode facing up. The two remaining electrodes can each be working and counter electrode, but the working electrode should ideally be equipped with two wires (I and V) to eliminate the wire impedance from the measurement.

Connect the inner electrode as usual, and place the seal and the sample.

For the case with **ring reference electrode**, place the ring electrode contact (e.g. GR18) over the sample contacting the reference electrode. Place an alumina spacer ring over this. Have a groove (or two) in the ring, and let the electrode contact wire(s) from the centre electrode pass in this over the spacer ring (see figure, top case). If this wire is not pre-pasted to the electrode, do that now, so that it fastens during the first heating. Add the spring load.

For the case with the **side reference electrodes**, no spacer ring is necessary – the centre electrode and reference electrode wires can exit without interfering with each other (see figure, two lower cases). Generally speaking, the spring load can also in this case not ensure contact to both the centre and the reference electrode. Therefore, it is advisable to pre-paste at least the reference electrode contact. However, it is possible if using point contacts instead of hand contacts to make the spring load top plate rest on up to three points simultaneously, e.g. two on the centre electrode and one on the reference.

8.3 EMF transport number measurements

8.3.1.1 General

In EMF measurements the voltage over a sample is measured under a gradient in activities over the sample. The gradient is established by supplying different gas compositions to the two sides of the sample. The voltage is measured by a high-impedance voltmeter, and is a measure of ionic transport numbers in the sample.

Measurements of total conductivity are easily performed during the emf-measurements by manual switching or automatic multiplexing, and the combination is a powerful tool in the investigation of the electrical conductivity of a material.

8.3.1.2 Sample

The sample needs to be a disk that can be sealed against the sample support tube so as to separate the two atmospheres.

The seal and the sample should be able to separate the two gases. A gas-tight seal of a glass, glass-ceramic, gold, etc. is preferable. However, also a purely mechanical fit between the sample and support can be acceptable if the leakage is minimised and its presence and effects are acknowledged. Depending on the magnitude of these leakages, the measured transport number will be smaller than the actual one.

Porosity in the sample may decrease the effective gradient like any other leakage. However, provided the gases are supplied to the electrodes comparatively fast, porosity need not affect the transport number measurement.

If the sample is a mixed conductor, or if it is porous, it is particularly important that the electrodes are of good quality; they need to pick up the voltage while not obstructing gas transport and should therefore be porous or point electrodes. A point electrode may have much noise due to high impedance, and all in all, a porous electrode is normally the best choice.

8.3.1.3 Assembly

Use the sample support tube with approximately the same diameter as your sample. Use a support plate with centre hole if the sample is smaller than your smallest support tube.

Mount the inner gas supply tube using a silicone hose and adjust so that the tube appears to be perfectly aligned with the top of the support tube (or the support plate if used). Check by actually mounting and tightening the support tube appropriately (and place support plate is used). Next, put the tip of the inner electrode contact INH2N12 or IN2 into the top end of the central gas tube and connect it to ILV and ILC. (If you will not be doing conductivity measurements simultaneously, the current connection (ILC) is not used, and the pair connection may be replaced by a single connection.) If the tube was properly aligned the 0.5 mm of wire now just extends over the rim of the support tube. The sample or a dummy disk pressed against the support tube should then easily press the contact down against the mild force of the hose.

The technique of contacting the lower electrode from the inside using INH2N12 or IN2 was described and illustrated in more detailed earlier, in the section on two-point conductivity measurements.

For the top electrode use either the 2-wire “hand” electrode contact (H2N#) or the general purpose electrode contact net (GP2N#) connected to general purpose electrode contact (GP1 or GP2). Connect to the HV feedthrough (and if you will be doing conductivity measurements, also to the HC current contact).

If you use a seal between sample and support (e.g. gold ring, glass ceramic, or other) place this before final assembly. If you use a support plate, this may in turn be sealed to the support tube.

Fasten the sample by the triangular spring load assembly.

If possible, use the bent quartz tube for gas supply to the outer chamber. Adjust the silicone hose so that the tube end just enters the centre hole in the triangular spring load tope plate. Do not allow the tube to press onto or even touch the top electrode of the sample.

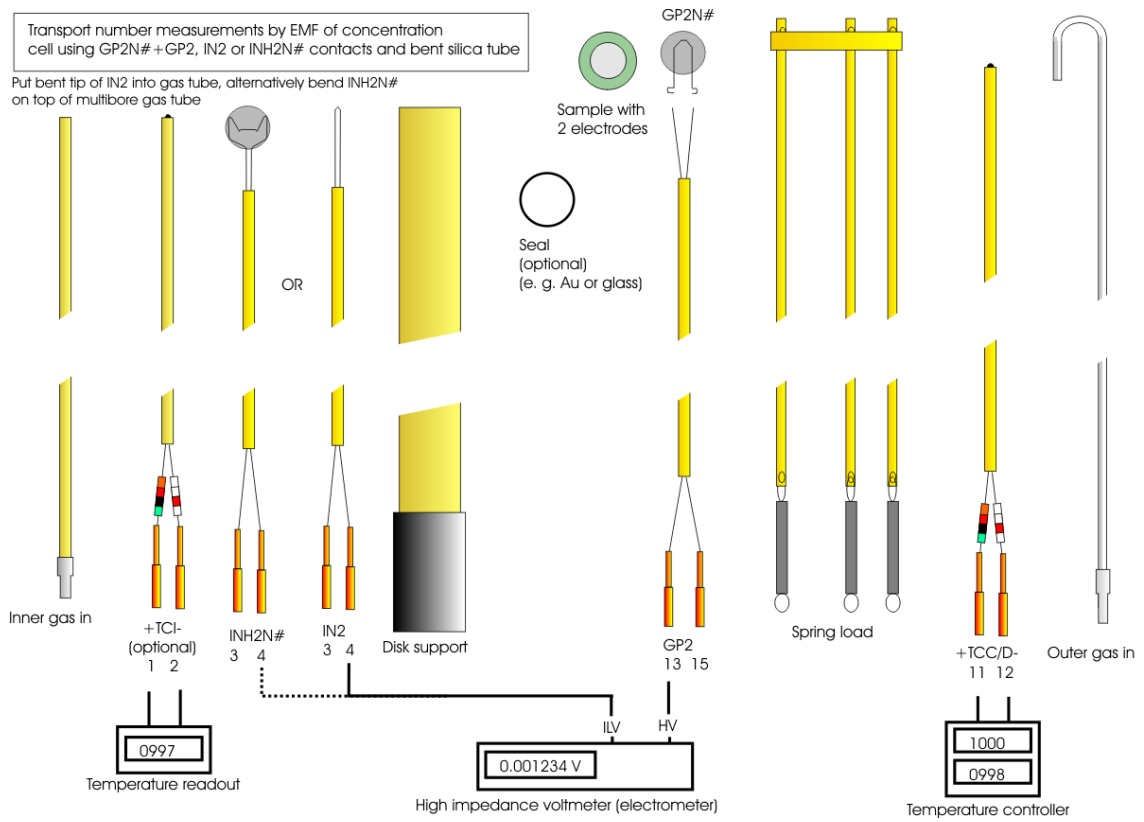

Figure 8-14. Schematic assembly of a setup for transport number measurements based on the emf of a concentration cell. The inner electrode is contacted with INH2N12 or IN2 (using one lead only). The outer may be contacted by GP2N#+GP1 or GP2, or H2N#. If using two wires, the extra wire is available for simultaneous conductivity measurements. The bent quartz tube ensures direct gas supply to the upper electrode. Seal by e.g. gold or glass.



Figure 8-15: Fully assembled emf concentration cell with bent outer gas supply quartz tube mounted with triangular spring load assembly

8.3.1.4 Measurements and interpretations

Measure the voltage over the sample with a given chemical gradient over it.

In the simplest approximation and under given assumptions, the ionic transport number averaged over the two chemical conditions is the ratio between the measured voltage and the Nernst voltage relating to the ionic charge carrier and the gradient:

$$t_{\text{ion}} = E_{\text{measured}}/E_{\text{Nernst}}$$

The background voltage, measured without a gradient, should be subtracted. (If the background voltage is unexpectedly high, try adjusting the height of the cell and sample in the furnace to reduce a temperature gradient over the sample. Minimising the background voltage this way may anyway be a good starting point.)

Alternatively, the gradient may be reversed by swapping the two gases, and the corrected voltage obtained from the two measurements as

$$E_{\text{corrected}} = (E_{\text{forward gradient}} - E_{\text{reverse gradient}})/2$$

The use of reversed gradients is useful for instance in the case of small transport numbers and/or noisy conditions, as the direct reversal and correction of the voltage alleviates the comparison of data taken at different times, and increases the resolution of the method.

8.3.1.5 Special considerations

In a more detailed investigation of the behaviour of the cell, one may investigate the voltage over a range of gradients. This will reveal the background voltage and also the possible role of leakages, electrode polarisations etc. The slope of E_{measured} vs E_{Nernst} at $E_{\text{Nernst}}=0$ will in principle represent t_{ion} without effects of the background voltage and with minimised effects of leakages and polarisations.

The separate determination of the transport numbers of more than one ionic carrier can be obtained by applying gradients of different species in separate, independent experiments. For instance, an application of a gradient in hydrogen activity (e.g. through a gradient in water vapour partial pressure) may yield the transport number of hydrogen ions (normally protons), while a gradient in oxygen activity will yield the oxygen ion transport number. If the sample is an oxide the latter contains and cannot be separated from the cation transport number. If the oxygen activity is applied at constant water vapour partial pressures, there will be also a gradient in hydrogen activity, and the hydrogen ion transport number also adds to the voltage. A ternary or higher oxide is in principle undefined if only the oxygen activity is controlled, and results may be affected unpredictably by cation transport unless also the activity of component cations are controlled appropriately.

Measurements of samples with high impedance may require special precautions. These comprise reduction of noise by averaging and shielding techniques and the use of floating or grounded measurements depending on conditions. Of less obvious importance is the effect of the shielding and guarding system. This, as constructed for impedance measurements, connects all shields together. This reduces the impedance of the system. This is not detected by impedance spectrometers, which rule out current running in the guard system, but still steals current from the cell voltage and may partly or wholly short-circuit the emf of the cell. To measure emf's on high impedance samples increase the impedance of the cell by removing the shields bridge, connect only one shield (on the high signal) to the ground terminal of the voltmeter, and keep the cell base unit hot and dry (to avoid conduction between leads and base metal over condensed water vapour). The removal of the shields bridge may make you unable to do simultaneous conductivity measurements unless you can make the necessary connections outside the cell.

The above issues are treated in more detail in the literature.^{1 2}

¹ T. Norby, "EMF Method Determination of Conductivity Contributions from Protons and Other Foreign Ions in Oxides", *Solid State Ionics*, **28-30** (1988) 1586-91.

² D. Sutija, T. Norby, P. Björnbom, "Transport number determinations by the concentration cell/open-circuit voltage method for oxides with mixed electronic, ionic, and protonic conductivity", *Solid State Ionics*, **77** (1995) 167-74.

8.3.1.6 Suggestions

After measurements, seals of gold, glass, etc., may be detached by unscrewing the support tube and heating it in a horizontal furnace until the seal melts and the sample falls off by gravitation. Place a longer, thin alumina tube inside during heating and check the opening with this. Alternatively, place support tube or entire cell upside down in your vertical furnace. Take care to avoid heat rising to the cold end parts by insulation, cooling, and/or keeping distance.

8.4 Fuel cells and electrolyzers (electrochemical reactors)

8.4.1 General

This section covers mainly measurements of DC currents and voltages. If a current is drawn from the sample, the cell may be called a fuel cell. If the current is applied to the sample, the cell may be called an electrolyser or, in more general terms, an electrochemical reactor.

The electrical analysis may for such applications be accompanied by analysis of gas compositions at the outlets.

8.4.2 Disk samples (button cells)

The sample should be a gastight disk, sealed to the appropriate support tube. It should be as thin as possible to allow large currents, but on the other hand thick enough to be self-supporting. It should have electrodes with good current collection. A reference electrode is desirable to separate anode and cathode polarisations, but not necessary for many uses, and considered impossible to implement properly if the electrolyte is thin.

Use a support tube assembly of suitable diameter and mount the sample with seal as necessary.

For the top electrode use, for instance, either the 2-wire “hand” electrode contact (H2N#) or the dispensable net GP2N# with short terminals connected to general purpose contact (e.g. GP2). Connect the pair in any case to the HV and HC feedthroughs.

For the lower electrode you will normally use the inner electrode contacts, such as an INH2N12 fastened to a multibore inner gas tube (Figure 8-16) or an IN2 bent over and into a 3 or 4 mm inner gas tube (Figure 8-17). In order to use inner electrode contacts to the lower electrode, do the following: If not already done, mount the inner gas supply tube using a silicone hose. Adjust the hose onto the tube so that the tube appears to be perfectly aligned with the top of the support tube. Check by actually mounting and tightening the latter appropriately. Next, put the bent top of the inner electrode contact into the top end of the central gas tube and connect it to ILC and ILV. If the tube was properly aligned the half a millimetre of wire now just extends over the rim of the support tube. A sample or a dummy disk pressed against the support tube should then easily press the contact down against the mild force of the hose.

In fuel cell testing it is common to use electrode net and wires painted or sintered onto the sample faces. This may help current collection. It also enables the placement of a reference electrode on the top face of the sample. Such wires are to be contacted to the general purpose contacts (GPI or GP2). The upper main electrode should be contacted to HC and HV, while a reference electrode may be contacted to LV. The lower electrodes may be connected to the ILV and ILC contacts. If the lower electrode has fixed leads, they may be contacted to the inner electrode contact leads and the leads then folded down into the inner chamber during sealing of the cell. With a non-conducting seal, the leads may also be fed through the seal and out to the LV and LC contacts. A sample with 5 leads (2 + 2 for main electrodes and 1 for top reference) can be contacted in the outer chamber if a free feedthrough for the upper thermocouple is taken into use. This may then be accessed through the thermocouple plug or one may reconnect the wiring in the connector box of the base unit.

The main electrodes are to be connected via the HC and LC contacts to a potentiostat/galvanostat or a passive load. The voltage probes and reference electrode if used may be contacted to the voltage inputs of the potentiostat/galvanostat in ways depending on the capabilities of the potentiostat/galvanostat and the desired measurements. In any case, an extra voltmeter may be connected to monitor the voltage over the main electrodes or between one main electrode and the reference.

In the following we will include schematics of various setups of fuel cells and electrochemical reactors for the sake of example.

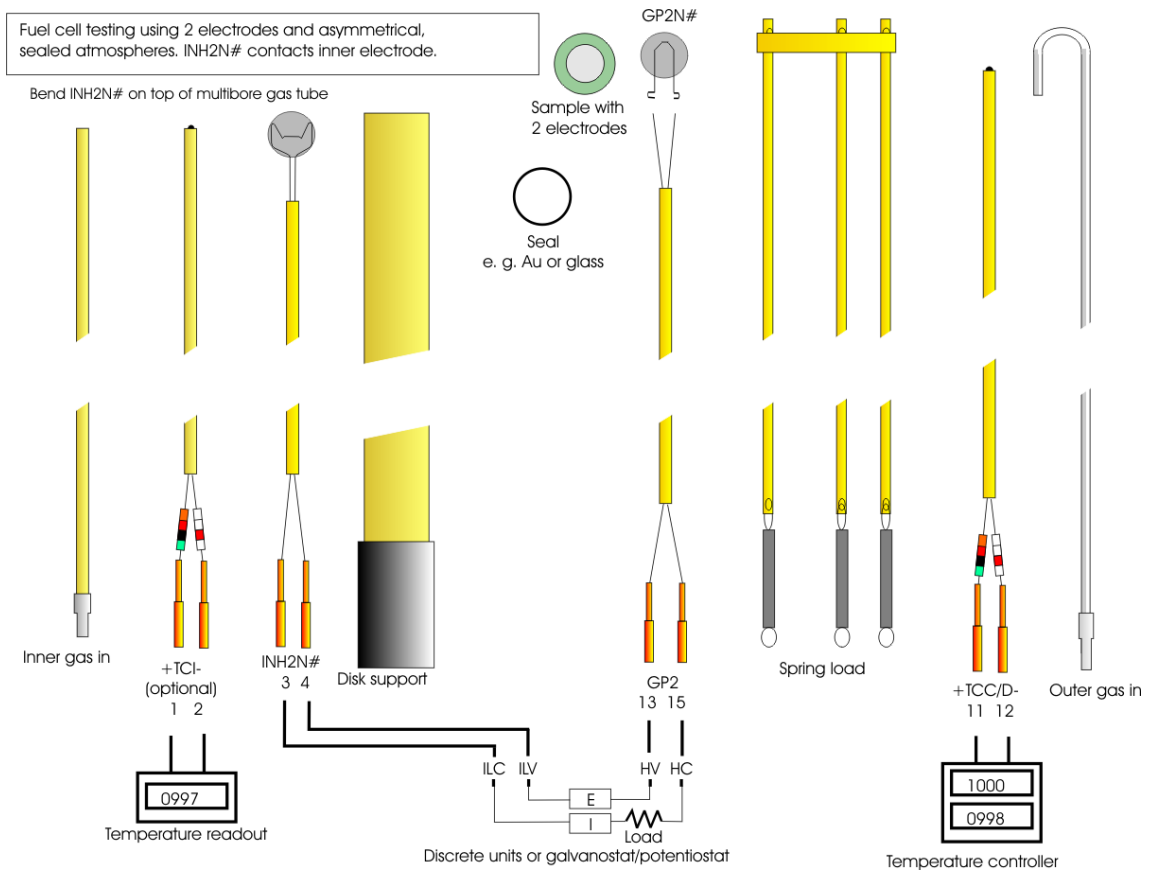

Figure 8-16: Schematic setup of fuel cell test using two electrodes only, contacted by INH2N12 over a multibore tube and GP2N#+GP2

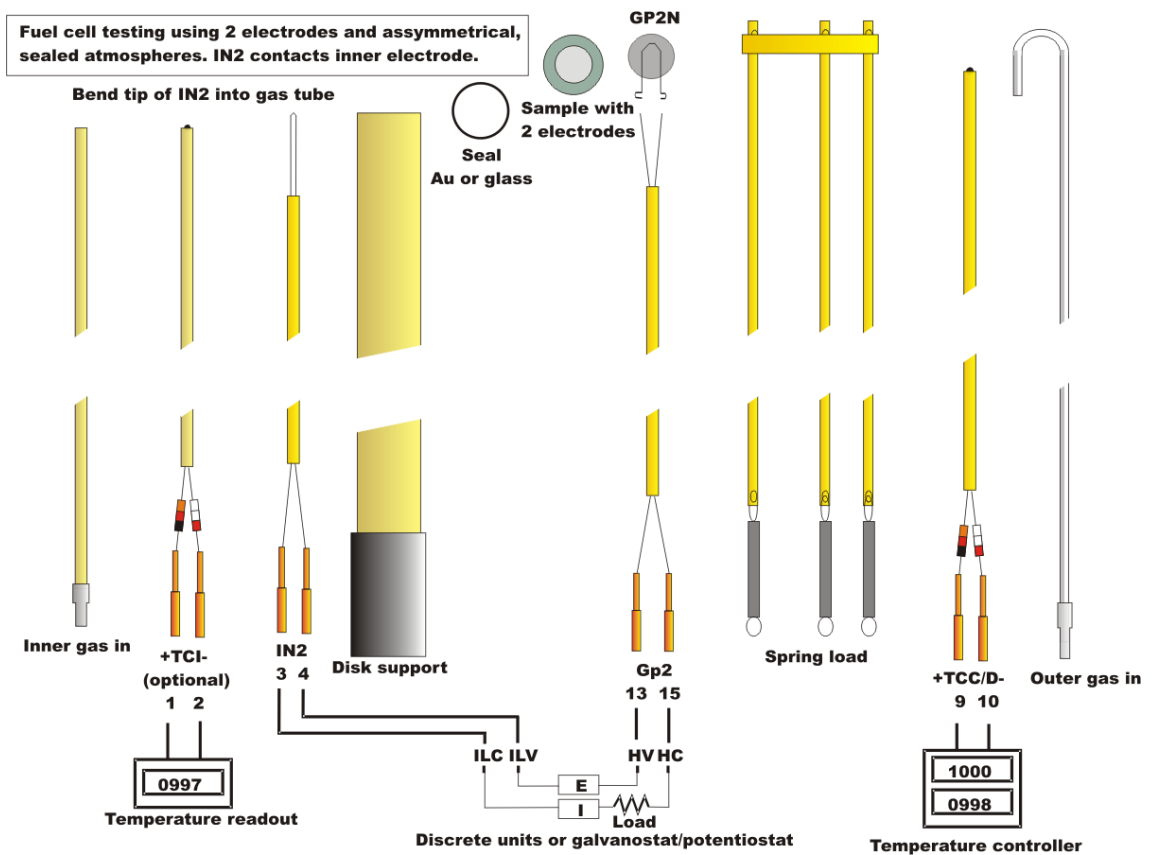

Figure 8-17: *Schematic setup of fuel cell test using two electrodes only, contacted by IN2 over a simple Inner-gas-in tube and GP2N#+GP2. The use of separate (discrete) voltmeter and ammeter (or potentiostat with four terminals) eliminates wire resistance losses. The use of bent outer quartz gas tube ensures minimum gas phase polarisation.*

8.4.3 Tubular metal-supported SOFC and SOEC

Solid Oxide Fuel Cells (SOFCs) can be applied onto porous or holey metal support tubes made of e.g. heat-resistant alloys in the form of a solid tube with drilled holes or a porous tube sintered from the alloy powder. The layers of the SOFC applied onto the tube will typically be a contact and protective layer, the anode layer, the electrolyte layer, and the cathode and current collector.

Alternatively, the support may be made of a cermet consisting of a composite of the electrolyte and an electronic conductor such as Ni. The electrolyte is applied on the outside in similar manners as for the alloy support.

In any case, the electrolyte must be dense, while the electrodes must be porous. The fuel is run inside the tube and the oxidant – normally air – is run in the chamber outside the tube.

Solid Oxide Electrolysis Cells (SOECs) can be built up similarly by running the cell backwards, supplying water vapour (steam) and extracting hydrogen on the inside and oxygen on the outside.

While tubes like this do not offer the same power density as planar stacks, they may be more robust for certain demonstration and research projects and – perhaps most importantly – have cold seals.

The ProboStat is suitable for running one such tube. The tube is in this case mounted to or as a socket to the ProboStat pedestal, and the tube thus replaces the commonly used support tube. The tube must be closed in one end, and this can be part of the tube as such or the end may be closed by welding or cementing on a stop plate or by other means.

We suggest to make windings in or on the tube open end, or to weld the end to a NORECS ProboStat socket, or to prepare the socket to accept the tube via bayonet or flange fastening. The cell then needs no contact to the support – the contact is the metallic tube itself. However, the outer electrode needs contacting and current collection. For instance, a mesh and/or wire of Pt, Au, or Ag may be wound around the electrode, fastened with a conducting paste, and one or two wire ends left for contacting. Or one may use a top cap connect, using a spring load if necessary, see *Figure 8-18*.

In the following we mark the main items you need in **boldface**. If you are setting up the actual experiment for the first time, we suggest that you read through and check that you have and understand each item. Consult the ProboStat manual or your local supplier or NORECS if you lack parts or have questions.

Start with a normal, bare, **ProboStat base unit**, preferably of stainless steel if the tube socket is of steel. Mount it on its stand and add the setup stand ring which will hold parts during setup.

Attach an open-ended **inner alumina gas supply tube** of suitable length to the central gas hose stub on the pedestal, using a short length of silicone hose. The length of the tube should be such that it reaches almost to the end of the closed tubular cell that we mount next.

Optional: If the tubular cell is wide enough inside, you may add an **inner thermocouple**, TCI, to the thermocouple feedthroughs of the pedestal.

Add the **tubular SOFC/SOEC**. If it needs to be screwed onto the pedestal or socket, the parts inside (gas supply tube and thermocouple) must have enough space to remain still. Be sure that there is an O-ring at the pedestal for cold-sealing the inner and outer compartments of the cell.

Contact the outer electrode by one or two **electrode contacts** such as two GP1s or one GP2 connected to the HC and/or HV terminals (feedthroughs 15G and/or 13G). The contact between the wires can be done by twisting, clamping, welding, etc.

Add the outer **control thermocouple**, TCC, and, preferably, encapsulate it with a **thermocouple cap tube**.

If an outer enclosing tube is to be used, add a straight alumina **outer gas supply tube** using a silicone hose to the gas stub in the outer chamber. Finally, mount the **outer enclosing tube** (quartz, alumina, or steel).

Insert the assembled ProboStat in a vertical tubular furnace, high enough that the centre of the active part of the SOFC/SOEC coincides with the centre of the warm zone. Note that the centre of the warm zone may be a little higher than the middle length of the furnace.

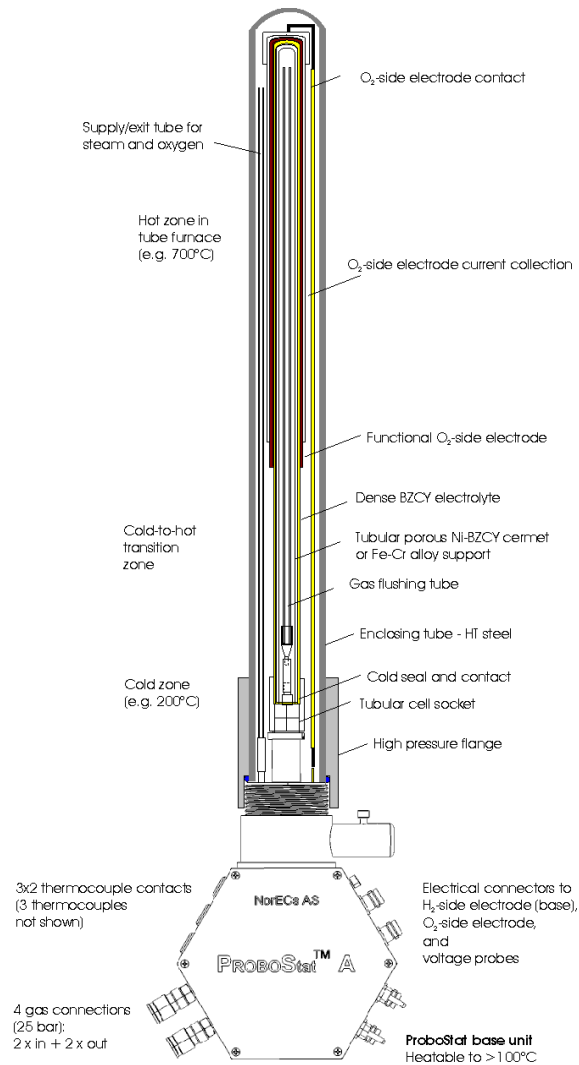

Figure 8-18. Schematic example of ProboStat setup for SOFC or SOEC testing using tubular BZCY-Ni cermet support tube with BZCY electrolyte film, an outer O₂-side electrode, and a current collector contacted by a top cap.

One electrode – on the H₂-side - of the SOFC/SOEC is in direct contact with the chassis of the ProboStat. In order to make that available to your external wiring, you can simply clip on to some part of it or use the Earth screw on the hexagon. More elegantly, you can use the ProboStat switches: “HSC+Ch.” (down) connects the chassis to the HCS (shield of the HC BNC). Moreover, “HCS+LC” (down) connects the HCS to the LV BNC (centre) terminal so that you if desired can access it with a normal BNC wire. However, note that the support tube electrode under any circumstance is connected to the chassis, and through the chassis mechanical mounting, gas tubes, etc., also to the general ground system and earth.

The outer electrode is available as one or two connections at HC (and HV).

8.4.4 Connections for fuel cell and electrolyser

8.4.4.1 Electrical instrumentation

Connect your potentiostat, galvanostat, multimeter, and/or impedance spectrometer depending on the experiment and measurement. The cell is a two-electrode cell. If your instrument has 3 or 4 terminals, i.e., separate terminals for current and voltage (e.g. working+reference and if applicable counter+reference) then use separate wires as much of the length as possible in order to reduce voltage loss in the wires and connections, and connect the two together as close as possible to the operating cell. For the outer electrode this means using the HC and HV separate if possible. If you only have one (HC), then split it using a BNC T-joint or banana jacks at the ProboStat. For the anode, similarly split the connection to the chassis at the ProboStat.

Be aware that the current rating for ProboStat minicontacts is 3 A for continuous long term operation. Higher currents can be passed for shorter times. To increase current capacity, use two feedthroughs in parallel.

The ProboStat has a shields bridge (switch “Shields br.”, down) which connects all the BNC shields together. Engage it (down) if connecting a pure impedance spectrometer to the ProboStat to ensure that current flows between the shields. All other instruments such as potentiostats/galvanostats require or prefer that the shields are kept separate (shields bridge switch up).

8.4.4.2 Thermocouple connections

Connect the thermocouples you use to temperature controller, temperature readouts, or voltmeters as required, using compensation connectors and cables. Check that a controlling thermocouple is of the same type the controller is configured for. Also check that it is mounted with the right polarity (indicated temperature increases – not decreases - as soon as heating starts) and not short-circuited (indicated temperature remains at room temperature even after the cell obviously has heated up). If reading a thermocouple using a (milli)voltmeter, be sure to add the room temperature junction voltage from a table before reading the temperature from the same table.

8.4.4.3 Cooling water

Connect low-pressure water at a small flow to the lower cooling water intake and let it out through the upper, using the designated hose.

8.4.4.4 Gas connections for SOFC testing

Connect the fuel gas line to the INNER IN gas inlet using a quick-connect stem with valve. Connect the fuel exhaust INNER OUT to safe ventilation.

If using an outer enclosing tube, connect the air supply to the OUTER IN.

The gases must have regulation of pressure and flow for stable and safe operation.

Preferably, one should have the possibility to mix the fuel with an inert gas for safe flushing of the system and for slow startup of the reduction of the anode and cell as such.

It is common for fuel cells (also SOFCs) to humidify the fuel for prolonged lifetime of anode and noble metal parts (Ni, Pt...). Some fuel cells and measurements (e.g. with proton conducting electrolytes) also benefit from humidifying the oxidant (cathode) gas. A simple and safe way of humidifying a gas is by way of plastic bubblers, such as NORECS’ “Probble” designed for small flows and overpressures. (Do not use glass flasks!) Cells with metallic supports may or may not benefit from humidifying the gas(es), depending on the alloy, type of fuel, etc.

A Probble also can be fed the output of the same cell chamber so as to visualise the actual flow coming out, routing it to ventilation through a common hose, and regulating the overpressure in the chamber, thereby also gaining some control of the effect of leakages in the SOFC structure.

NORECS' FCMix and its Probble humidifiers are designed for the job, allowing flow regulation of the gases, to mix in an inert gas, to provide overpressure safeguard, flow visualisation, and humidification. If you use Probbles for their pressure and flow controls this system, but want to reduce the level of humidification, retract the inlet plastic tube of the Probble to above water level (see also the Probble instruction manual).

8.4.5 SOFC and SOEC tests

8.4.5.1 Suggestions for SOFC startup procedures

The procedures for starting and running the experiments and measurements depend on the configuration, the materials, and the purpose of it all, and are the responsibility of the user. Here are some suggestions to be considered, examples intended to apply to an YSZ or similar electrolyte with an unreduced NiO-YSZ cermet anode and LSM cathode applied and sintered/annealed to a metallic porous support tube.

Use eye protection when working with pressurised or flammable/explosive gases.

At room temperature: Check that the cell is not short-circuited, namely that the cathode wires are not in contact with chassis/ground. Apply inert gas to the anode and for instance air to the cathode and check that gases flow as expected. Check for large leakage between the cell chambers and the outside world and between the cell chambers (presumably through the SOFC structure) by using the features of the Probble or similar (see its manual). Leakage to the outside world is unnecessary and results form an incorrect seal or gas connection or a materials fault. Small leakages between the two chambers through the SOFC structure are common, and need not be dangerous or detrimental for running the fuel cell, especially if keeping proper control of the overpressures of the two chambers and understanding the operation of the setup.

If all is OK, run inert gas on the fuel (anode) side and air on the cathode side. Suggested flows are in the range of 10-30 ml_n/min.

Heat the cell to the temperature you want for annealing electrode pastes, for reducing your anode, or operation, typically in the range of 800-1000 °C. The ramp speed is your choice, but slower is safer to avoid cracking of the ceramic layers.

NOTE: Check that the thermocouples react normally at heating, so that they are not inverted or shorted.

If you can, connect a voltmeter or potentiostat or impedance spectrometer over the cell and record the open circuit voltage (OCV) or the impedance at any frequency (e.g. 1 kHz) while heating. They will be noisy at low temperatures but get increasingly meaningful as you approach the higher temperatures, and are good indicators of events. More importantly – keep them recording while reducing the anode (next).

When the cell has stabilised at high temperature, increase the content of hydrogen H₂ in the anode gas, for instance to 10%. (This is not dangerous – any leakage in the cell at high temperature will simply lead to combustion of the H₂ to form H₂O – but you must still wear eye protection for any unforeseen events.) The hydrogen will start to reduce the anode's NiO to Ni, making it conductive. This – and the presence of H₂ - will make the OCV of the cell increase towards the Nernst voltage of around 1 V. If you measure the impedance it will fall by orders of magnitude probably into the ohm range.

The reduction of the NiO to Ni may complete and stabilise the cell properties or it may need a higher temperature and more time, or it may crack the cell. These processes are indicated by the voltage and impedance developments.

How close the final OCV comes the Nernst voltage is a result of how leak-free the cell is compared to the flows in the electrodes and total pressure difference between the chambers. You can reduce the effect of leakage and optimise the OCV by adjusting and normally equalling the overpressures of the two chambers by using for instance the bubbling heights of the return gases. The Probble is designed for this function.

If the voltage or performance of the cell becomes unstable, it may reflect that water from combustion or leakage or running the fuel cell condenses out in the outlets of the cell and clogs them. In this case, consider to reduce cooling of the base unit and perhaps even heat parts of the gas line.

8.4.5.2 Operation of SOFCs

If the cell exhibits a reasonable OCV, one may apply a varying load or use a potentiostat/galvanostat and draw current. It is suggested to keep the voltage at 0.5 V or higher to avoid oxidation of the Ni in the anode. The slope of output voltage over current is the effective overall resistance of the cell – counting everything from where the voltage terminals meet the current path. Impedance spectroscopy may separate electrode and electrolyte resistance contributions.

Cells with considerable areas such as the tubular cells, may deliver considerable currents. The minicontacts of the ProboStat are rated to 3 A for long term stable operation. Higher currents may be applied for short periods. For longer operation at high currents one may split the current on two feedthroughs.

8.4.5.3 Operation of SOECs

When supplying electrical power to electrolyse e.g. steam, be aware of the current limitations mentioned above for SOFCs. An additional danger for the ProboStat is the application of large voltages to drive electrolysis while steam has condensed in the bottom of the base unit: The water may - if only slightly contaminated - form an electrolyte which makes the minicontacts and base unit corrode when an electrical voltage is applied.

8.4.5.4 SOFC measurements and interpretations

Typical characterisation involves measurement of voltages vs current, from zero current (open circuit voltage) to some current or voltage regarded as a safe limit.

The voltage may be the total voltage over both working electrodes, to reflect the ohmic parts of the electrolyte (and spreading resistance in the electrodes) plus the various electrochemical pseudo-resistances of both electrodes. If the voltage is measured over a reference electrode, then only one electrode and one part of the electrolyte will be included. The measurement between the reference and the other working electrode should give the other contributions, and together they should sum up to the measured total impedance. The ability of the reference electrode to properly distinguish the impedances of the two electrodes relies, as a rule of thumb, on a good alignment of the two working electrodes as compared to the thickness of the electrolyte and the distance to the reference electrode.

The slope of the voltage vs current graph yields the impedance of the part of the cell that is measured. The graph often has two or three regions. Near the open circuit voltage, at zero current, there is apparently high impedance that reflects the ohmic parts plus the linear charge exchange resistance and other elements of the electrode reaction. However, it also often reflects a change in the atmosphere and thus of the reversible potential of the cell if products at the electrode(s) were not initially present. At higher current, the electrode overvoltage may surpass the so-called activation overvoltage at which the electrode behaviour becomes non-linear and has a lower resistance according to the Butler-Volmer-theory. Further, the atmospheres usually change less, and altogether these effects lead to a smaller slope and a lower derived overall cell resistance. At still higher currents the slope and the resistance may again become higher. This often reflects a limiting current because of mass-transfer limitations (diffusion). If the resistance appears to drop rather than increase at high currents, this may be due to local ohmic heating of the sample or parts of it (e.g. an electrode interface).

If there is main interest in the behaviour of one electrode, the use of a reference electrode and of impedance spectroscopy to find the ohmic parts (electrolyte resistances) are useful. After subtraction of the voltage due to ohmic parts, the remaining voltage is the electrode overvoltage. Plotting it versus log current in a so-called Tafel-plot can yield the activation overvoltage and the Butler-Volmer parameters as well as limiting current.

Simultaneous impedance spectroscopy and DC loading of the cell can give useful information: The total impedance (extrapolated to DC) should represent the slope of the current-voltage graph at the point it is

taken, and thus allows us to deconvolute the contributions to the current voltage behaviour. The measurements can to some extent be done with an impedance spectrometer alone, since they can superimpose a DC bias to the AC output. However, it is common to use the potentiostat/galvanostat between the impedance spectrometer and the sample.

DC characterisation can in many cases be done effectively with linear sweep voltammetry. If done at higher sweep rates also more information about electrode processes may be obtained, and in this case it is common to use cyclic voltammetry.

The information from impedance spectroscopy may be obtained also by current interruption: The cell is brought to steady state by a DC current. Then the current is abruptly zeroed, while the decaying voltage is followed. In its simplest form, the voltage vs. time contains an immediate drop, which represents the ohmic resistance, while the slower parts reflect electrode impedance.

8.4.5.5 Special considerations

The placement and use of reference electrodes is not straightforward in solid-state electrochemistry, especially of thin electrolytes and high-drain devices. The user must thus be careful in interpretations and consult the literature for further guidance.

8.5 Seebeck coefficient (thermoelectric power) measurements

8.5.1 Seebeck coefficients only

8.5.1.1 General

In this method a temperature gradient dT is established and measured over a bar sample, while the voltage difference dE is measured over it. As a specialised alternative for unsinterable powders, one may measure over a compacted powder filled into a thin tube.

The Seebeck coefficient (or thermoelectric power) is then $Q = dE/dT$. The voltage is, as we describe the method here, measured at the end faces/control points of a bar/compacted powder sample, while the temperature at either face/control point is measured with thermocouples.

To establish the temperature gradient, the cell is typically retracted downwards a few cm from the centre of the hot zone of the furnace. Gradients of 2-10 K are often suitable. The average temperature at the sample centre is controlled with the centre control thermocouple TCC/B.

Be aware not to retract the sample too much as the hot zone of the furnace may overheat out of its allowed range in order to try to get your sample centre to specified temperature.

8.5.1.2 Sample

A. Ceramic sample

Use a bar sample, preferably 3-4 cm long. It can have any shape, e.g. rectangular or circular, of its cross-section. It is easier to mount the bar steadily if it has a bigger rather than a smaller cross-section. For instance a 2×2 mm cross-section is quite difficult, while a 5×5 mm is easy.

The bar may be equipped with electrodes of Pt paste or equivalent at the ends to ensure that the electrodes have sufficiently low impedance.

B. Compacted powder sample

Pre-calcine material at the maximum experiment temperature in order to prevent the powder sintering at the measurements. Fill up the alumina container by the powder and compact it.

8.5.1.3 Assembly

A. For ceramic sample

Read *all* of this section (also after the figures) before starting, referring to the figures.

Use the bar sample support tube. Before mounting it, remove the inner gas tube, inner thermocouple, and inner electrode contacts, if any of these are mounted. Then connect the bottom thermocouple TCB supplied for Seebeck coefficient measurements to the TCB+ and TCB- feedthroughs (1P and 2N). Then mount the bar sample support tube. Place the floor support cut alumina plate at the bottom of the sample slit, letting the exposed leads of the lower thermocouple pass through the cut at the rear of the floor plate, so that the thermocouple tip can be pointed down on top of the floor plate.

On the floor, place the flat part of a one-wire “hand” electrode contact supplied (H1BN10) or made for this purpose. Connect to the LV feedthrough (8G).

Optional: connect internal heater contacts for the Seebeck measurements to the LC and LCS feedthroughs (5G and 6G) or to the HC and HCS feedthroughs (15G and 16G). Place the internal heater above the spring load triangle plate.

The bar sample is to be placed on top of the lower electrode contact (H1BN10).

For connection to the top of the sample, prepare one-wire “hand” electrode contact (H1TN10), connected to the HV feedthrough (13G).

When the sample and the wires are in place, put the short alumina rod as a roof on top, inside the sample support tube, and press it down using the standard triangular spring load assembly.

Prepare the top thermocouple (TCT) for contacting the upper electrode; connect the top thermocouple to the TCT+ and TCT- feedthroughs.

When the sample and electrodes are in place and held firmly between the floor and roof by the spring load, adjust the positions of the two thermocouples so as to point as much as possible directly at the electrode so as to get the temperature that the sample has where it is contacted by the electrode.

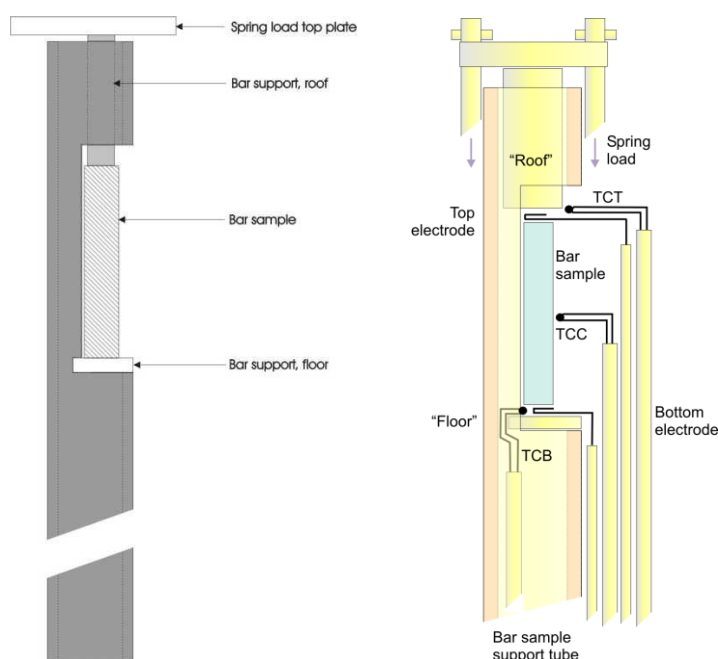

Figure 8-19. Left: Main principle of holding a bar sample in the bar sample support tube using its special accessories roof and floor and the spring load top plate. Right: More elaborate details showing how the electrode contacts and thermocouples are arranged.

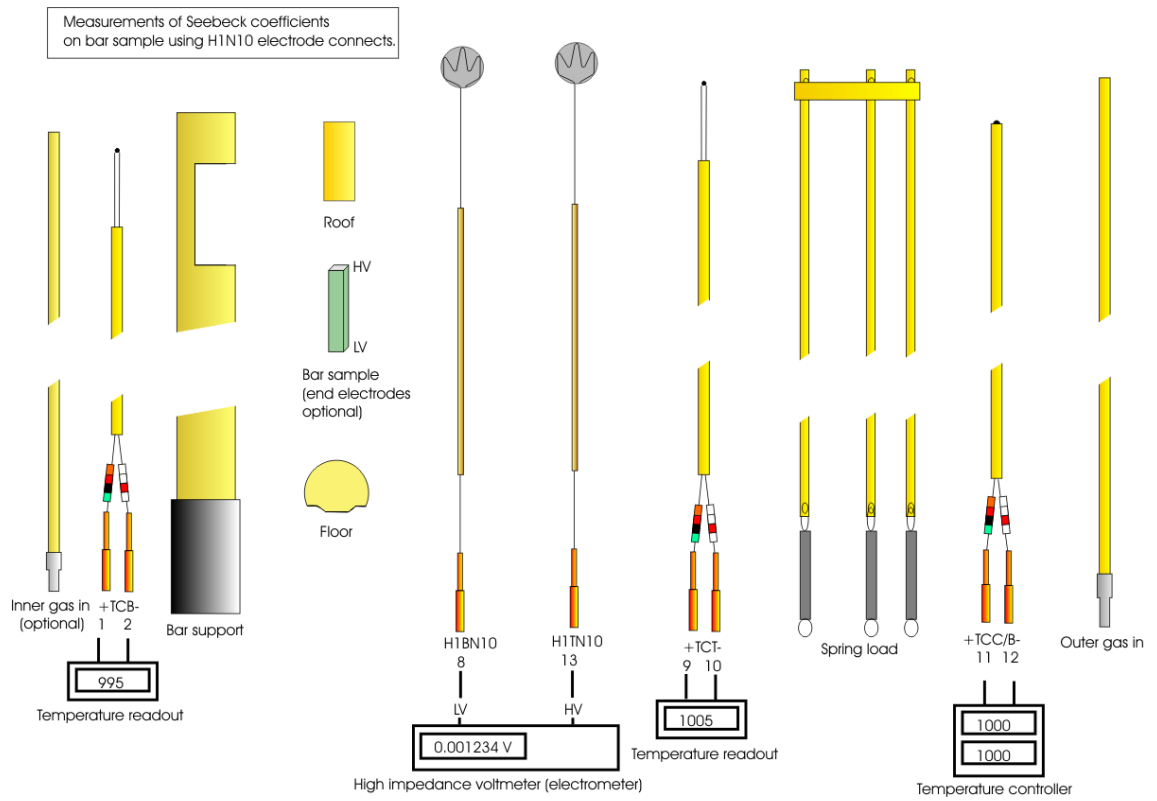

Figure 8-20. Example of assembly of Seebeck coefficient measurements using a bar sample. See Figure 8-19 for details of how electrode contacts and thermocouples may be placed with respect to the bar sample. No internal heater is shown, assuming one uses simply the furnace's natural temperature gradients (by moving the ProboStat in the furnace).

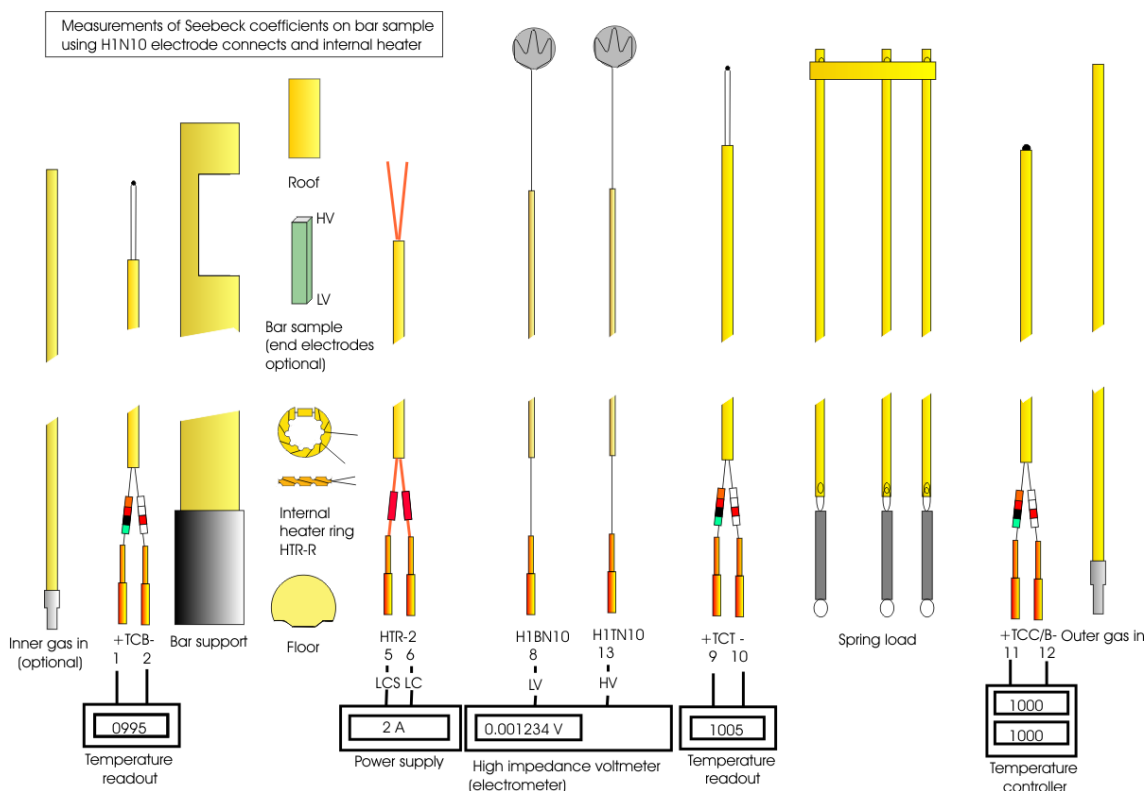

Figure 8-21. Example of assembly of Seebeck coefficient measurements using a bar sample and an internal heater. The internal heater shown as an example is a ring heater. (shown from above and from the side) that may be placed at the bottom around the sample and contacted using Au wires.

Make sure that the thermocouple wires do not touch each other before the tip.

NOTE: If the sample has a large enough cross-section, you may consider to place the thermocouple tips between the electrode and floor/roof, or even skip the electrode and instead use the thermocouple Pt wire as contact to the sample. This may give a more correct temperature reading. The voltmeter that is to make the reading of the sample voltage must then somewhere get access to the TC Pt wires. This can be done at the minicontacts, inside the connection box, or externally.

After all is done regarding the sample, mount the control bar thermocouple TCC/B and connect it to TCC+ and TCC- feedthroughs (11 and 12) and adjust its height to be aligned with the centre of the bar sample.

(For combined 4-point conductivity and Seebeck coefficient measurements, see below.)

B. For compacted powder sample

NOTE: This setup is not trivial, and how well it works depends on the powder and user's skills.

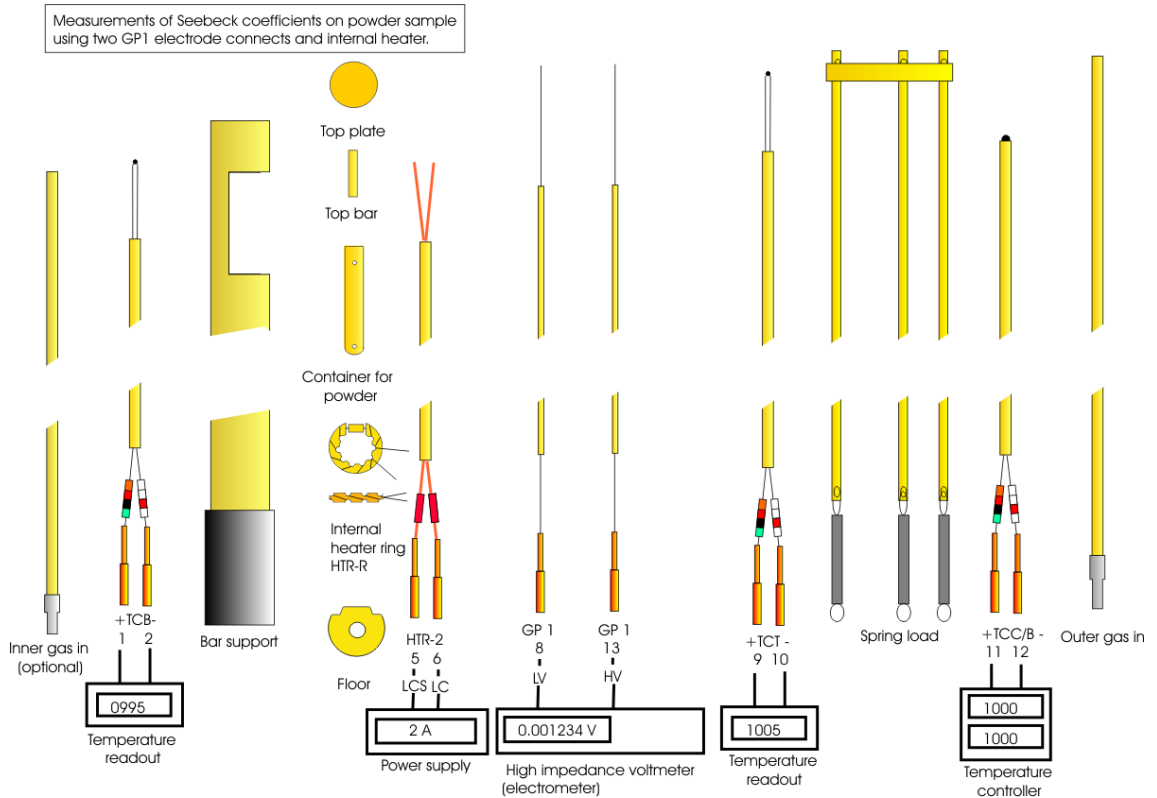

Figure 8-22. Example of assembly of Seebeck coefficient measurements using a compacted powder sample in a container with holes for electrodes and thermocouple.

Use the bar sample support tube. Before mounting it, remove the inner gas tube, inner thermocouple, and inner electrode contacts, if any of these are mounted. Then connect the bottom thermocouple TCB supplied for Seebeck coefficient measurements to the TCB+ and TCB- feedthroughs (1P and 2N). Then mount the bar sample support tube. Place the floor support cut alumina plate (with 6 mm Ø central hole) at the bottom of the sample slit, letting the exposed leads of the lower thermocouple pass through the cut in the rear of the floor plate, so that the thermocouple tip can be adjusted to the lower hole of the alumina container for powder sample.

Optional: connect internal heater for the Seebeck measurements to the LC and LCS feedthroughs (5G and 6G) or to the HC and HCS feedthroughs (15G and 16G). Place the internal heater bar above the spring load triangle plate.

Place the alumina container for powder on the floor support cut alumina plate with the central hole, put the short alumina road as a roof on top of compacted powder sample, inside the bar sample support tube, put the solid top plate on the alumina road and press it down using the standard triangular spring force assembly.

When the container for powder is on the place, prepare two single-wire electrode contacts (GP1). Connect the first GP1 electrode to the LV feedthrough (8G) and the second GP1 electrode to the HV feedthrough (13G). Put the Pt wires in the lower and upper inlets in the container.

It is essential that the contacts between the electrode contacts and the powder are good and there is not empty space around the Pt leads.

Prepare the top thermocouple (TCT) and connect it to the TCT+ and TCT- feedthroughs. Adjust the exposed leads of the upper thermocouple to the upper inlet for the electrode contacts in the container for the powder.

Adjust the exposed leads of the bottom thermocouple to the lower inlet for the electrode contacts in the container for the powder.

8.5.1.4 Measurements and interpretation (all Seebeck sample types)

Measure the two temperatures using the two thermocouples. Measure the voltage over the sample using the two electrode contacts. In the setup we have prescribed, you can measure the Seebeck coefficient at increasing gradient by moving the cell stepwise out of the middle of the furnace, while keeping the average temperature constant.

Optional: The temperature gradient can be created using the internal heater. Use a BNC/banana jack adapter on the BNC connected to the feedthroughs you have used for the heater inside the cell (normally the LC (or HC) BNC connector). Apply 0-5 A current to the internal heater for creating the temperature gradient.

Plot the voltage dE versus the gradient dT . It should form a straight line where the slope is Q . It goes through the origin if the background voltage is zero and the temperature difference is accurately measured. If the system is well behaved, and the background voltage is negligible, one may obtain Seebeck coefficients without measuring the slope by several points, but through only one measurement at one gradient.

If the hotter electrode is the positive electrode, then $Q = dE/dT > 0$, according to normal definitions. This reflects dominance of negative charge carriers, and would mean that n-type materials have positive Seebeck coefficients.

Thus many investigators choose to measure the voltage at the cold end versus that at the warm end and then get a sign for Q such that it is positive for positive charge carriers, such as p-type conductors.

Q may be given interpretations ranging from very simple approximations using the so-called Heike's formula to very complex expressions involving more than one charge carrier, more than one material, homogeneous and heterogeneous contributions, and elements of irreversible thermodynamics. It is probably fair to say that theoretical understanding and description of the thermoelectric power for many materials is lacking or debated.

8.5.1.5 Special considerations and suggestions

The thermoelectric voltage over a sample may be lowered erratically by the same causes as for the emf over concentration cells discussed earlier. For high impedance samples this relates to shorting by the measurement system. Remove causes for this by using a high-impedance voltmeter, ensuring proper insulation everywhere, and disconnecting shields. For low impedance samples, notably mixed conductors, internal permeation in the sample may polarize the electrodes, and it is necessary then to ensure that electrode paints, for instance, are conductive, porous, and catalytic. It may be informative to measure the impedance of the sample over the two voltage electrodes; for not too conductive materials and by involving impedance spectroscopy, this may yield both the sample conductivity and the electrode impedance. In evaluating the impedance of the sample in the Seebeck coefficient measurement, remember that the latter is a DC measurement, and that the electrode impedance not only adds effectively to the sample impedance, but also may affect the Seebeck coefficient and its interpretation more directly.

We have described the use of separate wires for the voltage over the sample and the thermocouples. Another possibility lies in using the thermocouples' Pt wires also for measurements of the sample voltage. For this purpose, one needs to make connections to the thermocouple wiring inside the base unit connector box or – more conveniently - externally.

Rather than measuring the absolute temperatures of the two thermocouples, one may connect the two Pt10Rh (or Pt) leads, and measuring only the difference in temperature over the two other leads. Rather than using two entire thermocouples, one may in principle make the connection between two equal leads in the hot zone of the cell: Connect one Pt wire from the TCB- feedthrough to the lower electrode, at which it is connected to a Pt10Rh wire going to the upper electrode, at which this is connected to a Pt wire going to the TCT- feedthrough. In either case, however, such connections between the thermocouples will short-circuit the sample and require that the thermocouples are insulated from the electrodes or other parts of the sample.

8.5.2 Combined Seebeck coefficients and conductivity measurements

8.5.2.1 General

A powerful possibility lies in combination of Seebeck coefficient and conductivity measurements. Most typically this involves utilisation of the bar sample geometry to make true four-point measurements.

8.5.2.2 Sample

Prepare the sample as described for Seebeck measurements, but with two voltage probes at for instance 1/3 and 2/3 length of the sample, as described for 4-point conductivity measurements.

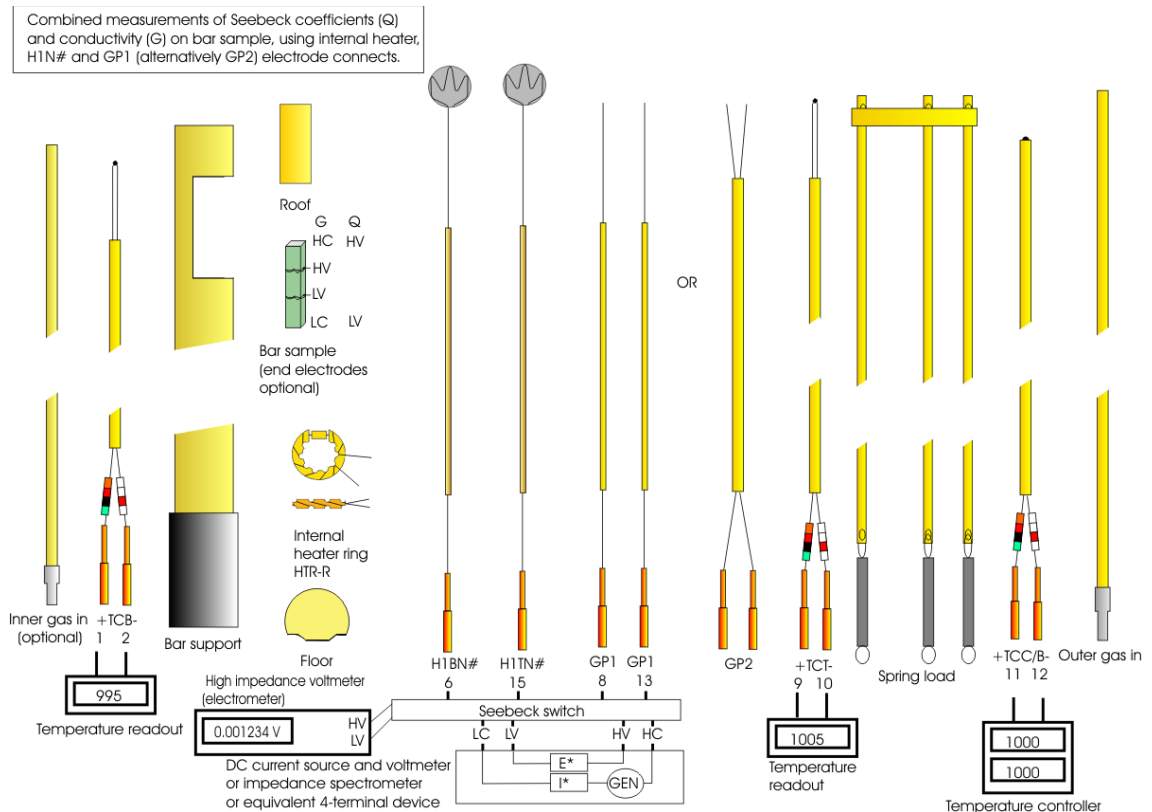

Figure 8-23. Example of assembly of combined Seebeck coefficient and conductivity measurements using a bar sample. An example of internal heater is indicated (ring heater) but its contacting Au wires are omitted for space considerations and clarity in the figure (see text.)

8.5.2.3 Mounting

Mount the sample with end electrodes and thermocouples as described for Seebeck coefficient measurements. However, connect the end electrodes to the HC and LC feedthroughs (15G and 6G). Connect to the two voltage probes using two general purpose electrode contacts (GP1) or one corresponding pair contact (GP2), to the HV and LV feedthroughs (13G and 8G).

8.5.2.4 Measurements and interpretation

Measure conductivity as described for the 4-point measurements earlier. Measure thermoelectric voltage over the HV and LV terminals, while having the impedance device disconnected.

The conductivity is measured while in a temperature gradient and is thus related to the average temperature, as is already the Seebeck coefficient. Since the Seebeck coefficient typically gives information about charge carrier concentrations, and the conductivity is a multiple of concentration and mobility, the combined experiment typically yields charge carrier mobilities.

8.5.2.5 Special considerations and suggestions

We have described the use of separate wires for the current/voltage over the sample and the thermocouples. Another possibility lies in using the thermocouples' Pt wires also for measurements of the sample voltage and supplying current for the conductivity measurement. For this purpose, one needs to make connections to the thermocouple wiring inside the base unit connector box or externally.

For high impedance samples it may be possible and sometimes even necessary to use 2-point measurements of the conductivity. For this purpose, use the two end electrodes and divide each into current and voltage terminals at the sample (by using a pair connection) or externally.

Combined Seebeck and conductivity measurement, involving switching in and out of sample terminals and instruments and possibly voltmeter measurement of two thermocouples, can benefit from automatisisation and multiplexing. For instance, automatic measurements in combination with a slow temperature ramp may automatically yield conductivity, Seebeck coefficients, and possibly mobility over an entire temperature range of interest.

8.6 Permeability measurements

In typical permeability experiments, a disk sample is sealed gas tight over a support tube, or one may use a tubular membrane sample with a cold seal.

A gas or gas mixture is supplied to one side, and one or more species permeate to the other side, where a sweep gas and/or pump collect the gas. The modes of operation are numerous, and so are the ways to analyse the permeation, including gas chromatography (GC) and mass spectroscopy (MS). Typically, an inert gas added to the entry side gas mixture is used for monitoring the presence or absence of background leakage through seal leaks or sample cracks and porosity.

In general, a large sample area is preferable, as it reduces the relative effects of leakage from seal gasket and general equipment. It also simplifies the considerations of sample geometry for samples where the thickness is not much smaller than the diameter so that permeation from the side is significant. However, a large sample may put higher requirements to the mechanical assembly and seal.

8.6.1 Disk membranes

The sample may be any gas tight disk or supported film that can be sealed onto the sample support tubes. Naturally, surface kinetics plays an important role and the user should pay attention to the surface roughness.

Mount an inner gas supply tube, adjusted to the desired distance from the top of the sample support tube. Then mount the sample support tube, remembering the support tube O-ring at the bottom. Put a gold gasket or other sealant in place on top of the sample support tube. Mount the sample, and hold it in place by a spring load.

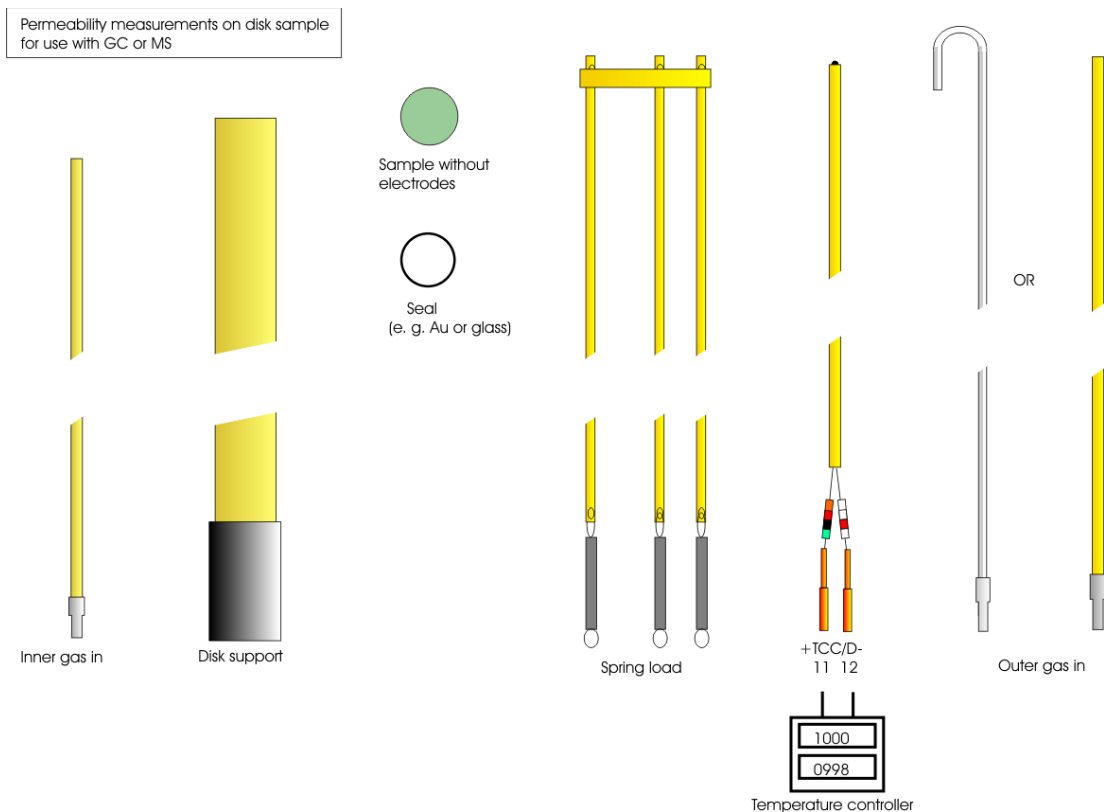

Figure 8-24. Schematic example of assembly of ProboStat setup for permeability measurements on disk sample using MS or GC for analysis. For faster responses one may reverse gases and use the “gas in” shown here as “gas out”.

If gas is to be supplied to or extracted from the top face of the sample, use a bent quartz tube as described before for the outer chamber. For less critical upper face gas streaming, or for prolonged testing at temperatures above 1100-1200 °C we suggest using the straight alumina tube instead.

Depending on the type of seal, heat the cell to the exact melting temperature or to around the softening or hardening temperature of the seal. If possible monitor the sealing by some means, e.g., GC, MS, or a pressure or flow measurement. Once the seal is tight, lower the temperature, and start measurements. You may not expect the sample to cool to room temperature without cracks due to thermal mismatch unless special care is taken to avoid it.

During measurements of permeability, we suggest to extract gas for analysis through the gas tubes and supply it through the cell compartment, i.e. in the reverse direction of that normally used in most other experiments.

8.6.2 Tubular membranes and catalytic membrane reactors (CMRs)

The ProboStat is ideal for testing tubular membranes, which are typically self-supported thick walled (symmetrical) tubes, or thinner films applied on a porous tubular support (asymmetrical). Tubular membranes may be sealed in the cold zone to a ProboStat socket using the same cement as we use to glue support tubes to those sockets. Alternatively, they may be fastened to the inner input gas stub by using a silicone hose, see Figure 8-25.

The test of membranes fastened to a socket is straightforward. Fastening it as a gas tube to the central gas-in stub allows a support tube to direct the gas past the membrane and to fill in a catalyst, making the setup a catalytic membrane reactor (CMR). For these, one needs to use the inner gas out connection to supply or extract the gas flowing past the membrane using a top cap. The outer gas in and our connections are then used to connect to the top cap, and to supply an inert flush gas.

Since the CMR setups above do not allow flushing of the inside of the membrane, NORECS has developed a special version of the ProboStat, named ProboStat CMR. This embodies an extra gas connection, a special dual socket assembly for mounting both the membrane and the catalyst support tube, replacement of electrode feedthroughs with more thermocouple feedthroughs, and a connector box that allows heating to 165 °C for high boiling point reactants and products. See NORECS web or contact NORECS if you are interested in this special option.

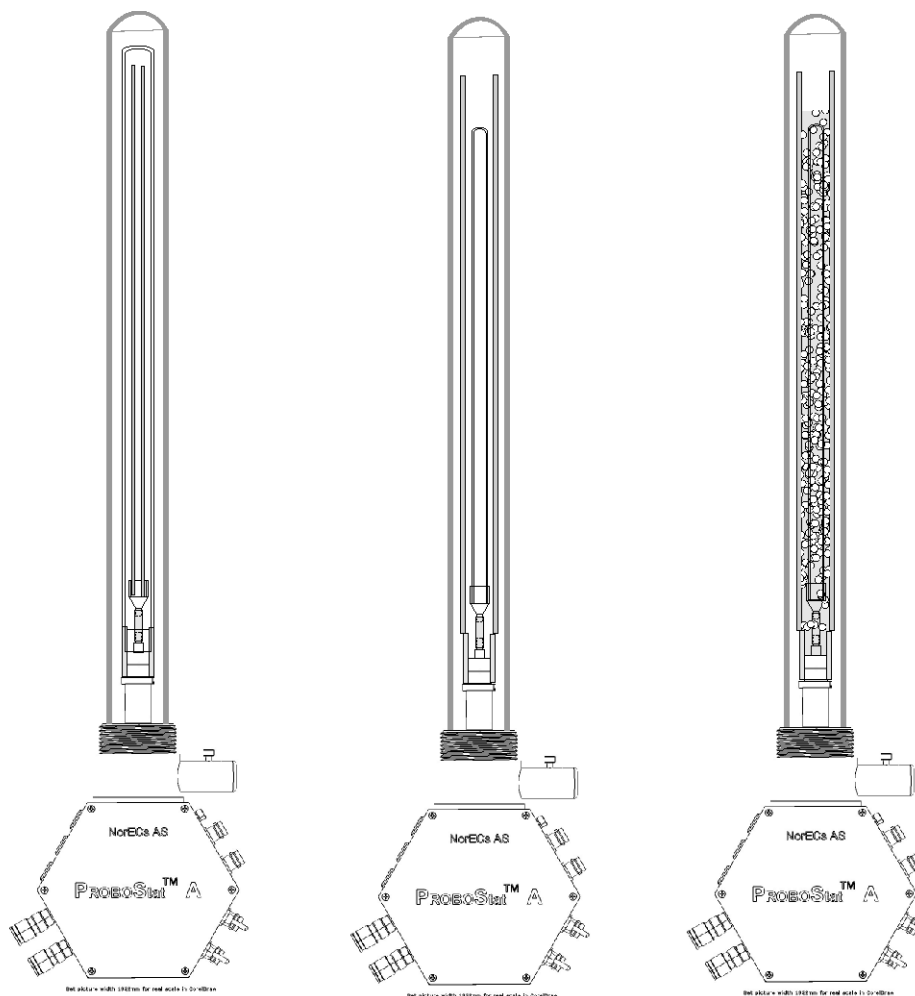

Figure 8-25. Schematic examples of ProboStat setups with tubular gas permeable membranes. *Left: Membrane is mounted and sealed to a support tube socket, allowing a gas flushing tube inside. Middle: Membrane is mounted as a gas-in tube, allowing a support tube outside that may be used to direct gas along the membrane outer wall. This gas may be supplied or extracted using a bent quartz tube and a top cap (not shown). Right: Same setup, but with catalyst filled in the support tube, making it a catalytic membrane reactor (CMR).*

8.6.3 Measurements and interpretation

Use a feed gas that contains an inert component not present in the permeate sweep gas. The analysis for this in the permeate reveals leakage of the cell. From this, the leakage contribution of the gas under analysis can be obtained via the contents in the feed gas and a proportionality factor, which is dependent on the type of leakage (e.g. Knudsen diffusion or conventional flow).

The analysis of the content of the permeating gas(es) in the permeate, multiplied with the exit flow rate of the sweep gas, yields the permeation (including the leakage and input level if present). (A typical error to avoid here is confusing the flow in normal units at 1 atm and 25°C with the un-normalised flow at high temperature in the cell.)

The permeation itself may be limited by bulk transport, surface kinetics, gas phase dynamics, and others, and the delineation is usually not straightforward.

9 Special experiments and conditions

9.1 Reduced noise and crossover signals

Noise reduction is an issue in most types of measurements. Below we describe some remedies for typical noise problems of external origin. (Be aware, though, that at high temperatures there will be thermal noise coming from the sample itself.)

9.1.1 High frequency noise

High frequency noise signals of all kinds may enter the cell through the non-shielding enclosing tube. This is primarily a problem for obtaining high-frequency parts of impedance spectra when the sample or electrodes have relatively high impedance.

You may try different remedies, preferably while the impedance of a high impedance sample is followed at a sensitive/noisy frequency, and/or while monitoring open-ended leads of the cell with an oscilloscope. We list them in the probable order of ease of implementation:

1. Connect the outer case of the furnace to Earth if you have not already done so. For this purpose, use the Earth terminal at the power supply system of your furnace.
2. If, and only if, your power supply delivers a floating output to your heating element, you may try to connect one of the outputs to the heating element to ground, as this may help the heating element function as a shield. (If you are not certain that the supply is floating, ask an expert or local electricity system responsible. The latter is a good idea under any circumstance. Earthing a non-floating system may blow fuses in the best case and cause danger.)
3. If the furnace has an insulating tube or otherwise ensures that the enclosing tube does not contact the heating element **and** the voltage of the heating element is floating **and** not high (i.e. < 45 V), you may consider the following possibilities:
 - a) Covering the enclosing tube with a metallic layer. The metal must be chosen with regard to the temperature applied (remembering that the outside of the tube temporarily may get hotter than the set-point temperature) and the cost. Typical metals would be Pt, Au, Ag, Ni, Cu, and Al. The layer could be applied as
 - i) Paint (e.g. of Ag, Au, Pt)
 - ii) Foil (e.g. Al, Au, Pt)
 - iii) Net (if enough space)

In any case, the metal must be contacted to the base unit block (which, in turn, must be grounded) or another ground terminal.

As these are fairly elaborate, we warn that it is still not certain that they will eliminate the problem you may have.

- b) Replacing the insulating enclosing tube with a conducting one. This may be a metal such as stainless steel, typically a tube with welded closure at one end. Alternatively, a SiC ceramic tube may be used. In any case, electrical contact to the base unit must be ensured, typically by a clamp ring on the tube and a wire to the base unit. One must be aware that a solid metallic tube will conduct heat efficiently from the hot zone to the base unit, and one has to restrict operating temperature or apply extra cooling. (We may make and deliver a steel tube of this kind on special order. It is in fact probably the easiest and cheapest solution *if* the safety aspects and temperature restrictions are acceptable.)

4. Shield the measurement wires in the hot zone of the cell. This is probably most important for the voltage leads. There are a few approaches to this:

- a) Use commercial high-temperature co-axial wires instead of the supplied Pt wires.
- b) Use a metallic tube outside the insulating alumina tube
- c) Paint the insulating alumina tube with metallic paint (e.g. Ag, Au, Pt)
- d) Wrap the insulating tube in a foil (e.g. Au, Pt, Al)

In any case, the metal shield has to be connected to ground. For this purpose, you may wrap one metal wire around all the shields and connect it to one of the shield feedthroughs, or you may do this individually.

An expensive and elaborate approach, comprising entirely Pt and alumina, is suggested here: It replaces the shields-connecting bridge assembly at the base unit with shields up the hot zone, bridging them near the sample. It is suitable for 2- and 4-electrode setups where you do not need the inner leads, for measurements over large ranges of impedance and frequency. Use the four measuring leads in the outer cell chamber. For each one, put the signal lead and an extra Pt (ground) lead in the two holes of a double-bore insulating tube (as used for thermocouples). Allow length for connecting at the bottom. Allow also ample length at the top (see below). Paint the tube with Pt paint or wrap it in Pt foil. Allow the ground lead a loop of 0.5 cm at the top before wrapping it downwards around its own alumina tube to contact the paint or foil. Connect each shield wire to its respective base unit ground feedthrough. (First remove the shields connecting bridge assembly). Connect all the shields at the top in the hot zone by wrapping Pt wire between the loops you left for this purpose at each shield wire. This system offers shielding and takes full advantage of the shield counter-current facility of advanced impedance spectrometers.

The inner chamber cell wiring has no ground feedthroughs. If you need to use shielding here, you may either sacrifice the thermocouple and use its feedthroughs, or let the current lead provide the shield around the voltage lead.

5. Cover the inside of the enclosing tube with a metallic layer, e.g. by paint or foil. This is not straightforward, and one has to ensure that the layer is contacted to the base unit block, while at the same time it does not contact any of the measurement and thermocouple wires or feedthroughs.

6. Build the entire furnace setup into a Faraday cage (a metallic housing which takes up all electromagnetic radiation) or use a room in your institute built as a Faraday cage, if there is one. For building such an elaborate unit, refer to special literature or consult experts.

9.1.2 Hum noise

Hum noise may enter as well, in most cases primarily from the heating element in the furnace. The remedies 2, 3, 4, and 5 mentioned above may help if the source is the heating element itself.

Further possibilities lay in using DC power e.g. through the use of a rectifying thyristor unit. Talk to your power supply dealer about this, and be sure to have a properly filtered output – a poor rectifier system may do more harm than good.

Hum is at a single frequency of 50 or 60 Hz. Since advanced impedance analysers are frequency selective and you can usually avoid or be without measurements at exactly the hum frequency and its overtones, hum itself need not be a big problem. More of a problem may be the high-frequency signals mediated through the heating system and created by the power regulator. Power control systems employing so-called phase angle control cut or start each sine wave somewhere in the middle of it and thus provides excellent control, but lots of noise over a wide spectrum. An alternative lays in pulse-train control, in which a number of sine waves in succession are on and a number are off over a given cycle time. Each pulse train is switched in and out at zero voltage (and current) and thus gives far less noise. The control stability of the large and slow systems that will typically be used with ProboStat at high temperatures will not suffer substantially with pulse train control, and this type of control is thus recommended.

9.1.3 DC stability and low frequency noise

When measuring DC signals of the sample or thermocouples, or extending AC impedance spectra down into the milli- or micro-hertz ranges, slow fluctuations in the background voltages are our main problem. They primarily arise from thermoelectric voltages due to thermal fluctuations at connection points between different materials. These are found at the sample itself, at the feedthroughs, and at the multi-connector out of the base unit. In order to stabilise the thermo-voltages here, try to reduce temperature variations in general, and ensure that wires experience remaining temperature variations equally. Temperature variations typically arise from varying heat radiation and other heat transfer from the furnace, varying cooling water supply, varying room temperature, direct sunlight, neighbouring furnaces, etc. Remedies comprise thermostating the cooling water, stabilising room temperature, preventing sunlight intrusion, having constant lighting, and shielding/insulating exposed parts.

9.2 *Very high temperatures*

The cell may normally be run without any special precautions up to around 800°C, and cooling water is normally not needed to this temperature range. With cooling water (or a cooling fan) the cell can normally be run without further precautions up to around 1200°C or above depending on how close the hot zone is to the base unit (i.e. how long the hot zone is). For extended exposure to temperatures above 1200°C, or short exposure to 1400°C or higher, use cooling water and do not use silica parts.

Be aware of the difference between brass and stainless steel base units: A brass base unit conducts heat well and thus provides good cooling of the glue, plastic and other vulnerable parts. (However with corrosive gases the brass itself may be in danger). A steel base unit is well protected towards corrosion by corrosive gases, but has poor heat conduction and cannot cool other vulnerable parts as well as a brass base unit.

As you go to higher temperatures the use of heat radiation shielding will increase the lifetime of the cell and its components.

Heat radiation shields can be made in different ways. It should be placed below the hot zone of the cell (typically at the end of the furnace tube) and should prevent heat radiation from the hot zone to hit the cold parts of the cell. It is most important to do this in the inner tube, because of the height of the pedestal and the distance from the cooling water.

One way to make heat shields is to lay heat resistant wool or cloth (silica wool, glass wool, Kaowool) around central parts, and wrap it up with Pt or other metal wire such that it remains in place when you lower the enclosing tube around it. This applies to both the inner, support tube and to the outer tube. A height of 1-2 cm of wool is enough. In the inner compartment, wrap the wool around the gas supply tube and electrode connects. In the outer compartment, the wool may be placed under and/or in between the spring load assembly rods, and the wrapping wire must not obstruct the function of the spring load.

9.3 *Over-atmospheric pressures*

The cell is designed for small overpressures typically resulting from gas mixers. Protection against overpressure resulting from unintended supply from a high-pressure gas line to a closed-off cell must be ensured.

If the O-ring sealing of the enclosing tube is left dry (free from lubricants) and tightened, it will withstand reasonable overpressures in the 0.1 atm range. However, this should only be trusted if you use non-hazardous gases. If you use hazardous gases or well-lubricated outer seal ensure that overpressures are kept below 0.02 atm (20 cm water column or equivalent).

You can work with higher pressures by installing a provision for mechanically holding the enclosing tube in place. We can deliver enclosing tubes with slits and base units with holes for screws that will hold the enclosing tube back. Nevertheless, with such measures, you must still ensure that pressures stay within

the range of safe operation with regard to local safety regulations, protection measures taken, the gases involved, the material of the tube, and the temperature.

NORECS fabricates also a stainless steel outer tube that can be used standalone or outside a ceramic tube. It allows higher pressures up to 15 atm depending on the temperature.

9.4 *Wet gases with dew-points above room temperature*

In order to work with gases with high water vapour pressures (dew point above room temperature, up to 1 atm pressure) the base unit must be heated accordingly. This can be done in different ways:

Skip cooling water so as to let the furnace and cell heat the base unit. Additional heating of the connector box and gas connection tubing may be necessary, e.g. by electrical heating ribbon or similar.

Use heated “cooling” water to heat the base unit. Additional heating of the connector box and gas connection tubing may be necessary, e.g. by electrical heating ribbon or similar.

Use electrical heating ribbons on the base unit and gas connections.

Use a hot blower on the base unit and gas connections.

Build the whole cell into a heated chamber. The furnace may be inside or outside. For instance, a thermostated heater (or cooling fan if the furnace is included) may control the temperature. Wetting stages may be placed inside. The temperature may be held, for instance, at the desired temperature of the wetting stage.

The standard base unit is designed to tolerate 85°C, but the external leads currently supplied with the cell tolerate only 70°C over extended time.

Alternatively, the high-temperature version of the ProboStat™ with heated gas lines can be used. The high temperature base unit is designed to tolerate 165°C.

If other parts such as the furnace or gas mixer parts are included in the hot chamber, be sure that they are designed for and safe at such temperatures. Do not let the hot chamber be filled with high humidity and do not let gases from the cell outlets into the chamber – connect the gas outlets from the cell to ventilation outside the hot chamber.

9.5 *Transient measurements*

Measurements of time constants involved in the relaxation of some property after an abrupt (step) change in some parameter can yield chemical diffusion coefficients. These can be of practical interest and can, in turn, also yield self-diffusion and other data under given assumptions.

It is of course essential to know the diffusion length, i.e. that the sample is dense or that it has fully open porosity so that you can assume that the grain is the body that the diffusion occurs in.

With ProboStat the most typical property to measure transiently would be the electrical conductivity. The mathematical relations involved can be relatively simple or more complicated depending on the defect structure and number of charge carriers involved³.

Typical experiments involve:

³ See, for instance, H.-I. Yoo, C.-R. Song, *Solid State Ionics*, **135** (2000) 619-23 and references therein.

Transients in oxygen partial pressure to determine chemical diffusivity of oxygen in oxides where the conductivity varies with pO_2 . This diffusivity is often related to the ambipolar diffusion of oxygen ions and electrons (or holes).

Transients in partial pressure of water vapour to measure chemical diffusivity of water in materials in which the electrical conductivity varies with pH_2O . This diffusivity is often related to the ambipolar diffusion of protons and oxygen ions. (See below for note on water partial pressure steps.)

Transients from H_2O to D_2O containing atmospheres or vice versa to measure the tracer interdiffusivity of H and D in materials where there is a H/D isotope effect on the conductivity. (See below for note on water partial pressure steps.)

Also emf-based methods such as Seebeck-coefficient or transport number measurements can give information in transients.

Here we discuss briefly how the atmosphere is best changed in a step-wise manner in the ProboStat. If the diffusivity to be measured is very high it will be essential that as many measures as possible are taken in order to have a close-to-ideal step.

First of all, a highest possible gas flow, without cooling the sample, should be used. We leave to the user to decide

Next, the gas should be established and reach and pass the sample in a uniform manner, so that the step in the gas composition is maintained. Dead ends and pockets should be avoided at any stage.

If the sample is a disk on a support tube (e.g. as measured in a van der Pauw setup) it is best to supply the gas simultaneously to both electrodes via the gas supply tubes in the normal manner. In order for the gas step to hit both sides simultaneously, consider arranging an extra small length of gas tubing at the inlet to the lower side, as this path is shorter inside the cell. Ensure that as much as the sample area as possible has free access to the gas. For this purpose, you may for instance arrange for spacers on the support tube and under the top plate. If you cannot use the bent quartz tube or a similar construction, and has to resort to a straight tube, this method will only work well with measuring slow diffusion processes.

If the sample is a bar sample or is otherwise not covering a support tube top, we still suggest to supply gas via the two gas supply tubes in the normal manner. If sharpness of the step is critical, we suggest to use a bar sample, attach four contacts, insulate these with thin alumina tube pieces and then slip the whole assembly down into a normal support tube of the samples dimension that can accommodate the assembly. Then, gas may be supplied only from the inner chamber connections. This may be done with both connections in parallel (without using the supply tube), so that the support tube is the gas channel, and letting the gas out through both outer connections in parallel. Or it may be done with the inner gas supply tube shortened to point directly at the lower sample end, letting the gas out through all three remaining connections.

NOTE: Gases close to their dew points, such as water and heavy water, are adsorbed on all surfaces, and this slows down and smoothens their concentration step considerably. To avoid this, keep all lengths and volumes as small as possible, avoid cold spots (e.g. proximity to cooling water lines) and use heated lines to the extent possible.

Finally we mention that if an ideal step is still not achievable, the slower change may also to some extent be included in the mathematics of the transient and thereby be taken into account. However, the sensitivity to distinguish processes (e.g. surface kinetics and bulk transport) is then much reduced.

9.6 Control and monitoring of atmosphere composition

The use of controlled atmospheres during measurements at high temperatures is a specialty of the ProboStat. Nevertheless, the establishment of controlled atmospheres is not entirely trivial. This is mainly done before the gas enters the ProboStat, and may require one or more of prefabricated gas mixtures, gas mixing, total pressure control, electrochemical pumping, wetting, and drying and other filtering/gettering.

We will here contribute with suggestions and advice on some of these topics.

9.6.1 Oxygen activity control and monitoring

In order to control p_{O_2} one usually uses mixtures of O_2 and an inert gas (e.g. Ar, N_2) for relatively oxidising conditions, $CO+CO_2$ mixtures for more reducing conditions and H_2+H_2O mixtures for even more reducing conditions. In both the latter types of mixtures, additions of inert gas (e.g. Ar) can be done to lower the activity of carbon and hydrogen without, in principle, affecting the oxygen activity.

Monitoring of p_{O_2} can be useful to check the actual activity, to provide feedback to a mixing or pumping system, or to provide information of instantaneous p_{O_2} in transient experiments. However, one should be aware that monitoring methods may have flaws just like control (mixing and pumping) methods.

Systems may be built with different levels of sophistication. For instance a gas containing water vapour or CO_2 may be led through three cells: The first has an oxygen sensor and an oxygen pump by which an appropriate amount of oxygen is pumped in or out to reach the desired p_{O_2} . The second cell has the actual sample and is where the measurement is done. The third has a sensor where the p_{O_2} of the gas leaving the measurement cell is monitored, as a check. One or more of the sensors may be integrated with the measurement cell if possible.

However, most users will settle with a simpler system, using a mixing or pumping stage and one sensor.

9.6.2 Integration of sensors in a ProboStat

Integration of sensors that are to be placed in the high temperature zone, close to the sample, is not part of the standard furnishment for ProboStats. However, the versatility of the ProboStat offers several ways of including sensors:

9.6.2.1 Concentration cell sensor using solid electrolyte support tube

The most obvious type of sensor is a tube of yttria stabilised zirconia (YSZ) or other solid electrolyte. Two of the ProboStat electrode connections are used to measure the voltage over the sensor tube, while 2, 3, or 4 electrode connections are used to measure the sample in 2-, 3-, or 4-electrode geometry. The inner gas supply is used for a reference gas for the sensor (e.g. air) while the outer gas is used for the sample compartment that is monitored by the electromotoric force of the sensor.

The solid electrolyte tube functions as a support tube for the sample in this setup, and one may for instance use a small alumina cylinder and plate to form a platform for a disk sample on top of the usually rounded electrolyte tube end.

The spring load of the ProboStat holds the sample and its electrode contacts in place and also the top electrode of the solid electrolyte tube.

The inner electrode of the solid electrolyte tube is contacted using the hose compression force via the inner gas supply tube, as in normal ProboStat operation.

The solid electrolyte tube must be equipped with electrodes; this is typically done by painting with Pt paste. On the inside this can be tricky. Be aware that solid electrolyte tubes such as YSZ are very expensive and very vulnerable to mechanical and thermal shocks and thermal gradients compared to e.g. alumina tubes.

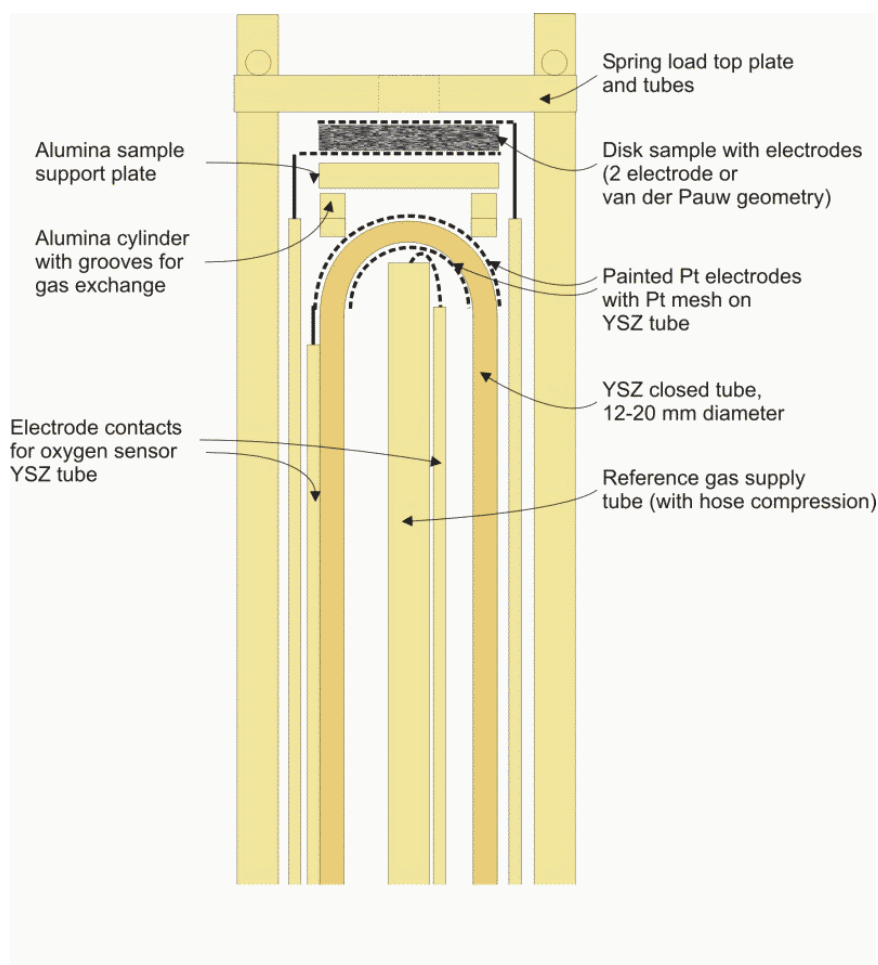

Figure 9-1. Suggested schematical setup of ProboStat with YSZ sensor tube as support tube. Measurements on disk sample can comprise up to 4 wires (e.g. 2-electrode or van der Pauw measurements) provided sensor connections are taken out through unused TCT thermocouple feedthrough. Outer enclosing tube, outer gas supply tube, thermocouple, and base unit are not shown for clarity.

One may use two thermocouples to ensure that the temperature inside the sensor tube is close to that outside. If using only one thermocouple, care should be taken to ensure thermal homogeneity throughout the sample and sensor area.

The setup of such a cell requires adjustment of wire lengths and some special use of electrical feedthroughs, but is otherwise straightforward. One must be aware of the limitations in the accuracy of YSZ as sensor electrolyte, and of the cost of the YSZ tubes.

9.6.2.2 Resistance-type sensors

By using two or four of the otherwise unused electrode or thermocouple connections one may include a 2- or 4-electrode resistance-type sensor. These are not commercial, but NORECS and others are working on the development of these.

9.6.2.3 Sensor/pump inserted through a top-flange in an open-end outer tube

One may use an open-end enclosing tube and use a flange to insert a sensor or pump this way, approaching the sample from the top. NORECS offers a solution of a commercially available sensor tube (with electrodes and thermocouple) and custom flange.

9.6.2.4 Sensor/pump attached to the gas stubs (from version A6).

From the ProboStat version A6 the centre gas stub is detachable (threaded) and similarly one or two detachable stubs (by sliding O-ring seals) can also be attached to the outer chamber. Onto these can be glued YSZ tubes of inner diameter 4 mm and outer 6 mm. If equipped with Pt electrodes, an electrode connect on the outside, contact to the inner electrode via a noble metal wire fed through the gas connect, and a reference gas, sensors and pumps can be envisaged.

9.6.2.5 Separate ProboStat units used for sensor/pump applications

One may of course use a separate ProboStat unit in its own furnace for sensor or pump applications, using closed YSZ tubes and/or resistance-type sensors.

9.7 *Measuring liquids*

NORECS manufactures a liquid sample cell inventory for the ProboStat to be used up to 200 °C.

NORECS may also deliver parts that allow one to measure a solid as it melts and in the molten state. This may work up to very high temperatures and provided that the melt does not react with the metal (typically Pt) or ceramic (typically alumina) parts.

9.8 *High voltage version of ProboStat*

The ProboStat may be ordered as a high voltage version, in which two feedthroughs otherwise used for shields are replaced by special electrode contact feedthroughs with special chassis contacts that allow up to 10 kV DC vs ground.

10 Auxiliary units

The following contains a few words on auxiliaries that you may typically use with the ProboStat, but which are not sold as parts of the ProboStat system.

10.1 *Temperature control system*

10.1.1 Furnace

A suitable furnace for ProboStat is typically a tubular design of inner diameter of 40 to 50 mm and length 50-80 cm. Power ratings of around 1500 W are typical. The furnace should be mounted vertically. Below the furnace there should be at least 90 cm of free space for loading the cell (from a stand on a table or on a rack). We would suggest to mount the furnace such that the lower end is at the height of the operator (e.g. 170 cm) above floor level.

10.1.2 Power supply

The power supply system is typically a controller, a thyristor or solid-state relay and a transformer.

If a transformer is needed, it should be of an insulating (floating) type if possible; this is more flexible and safer, but usually also more expensive.

A thyristor with pulse train regulation is preferable for low noise on the power supply net and to the cell. Pulse train period should be set fairly short so that good temperature stability is assured. A unit with phase angle regulation is preferable only if extreme temperature stability is required.

If there is a transformer, the thyristor may be placed before or after it. A thyristor on the primary side usually can operate at a lower current. However, it may be vulnerable to thyristor or fuse blow because of spikes from the net or from switching the very inductive load of the transformer.

NORECS manufactures a series of power supplies with temperature controllers specially designed for the ProboStat.

10.2 *Water cooling system*

The water cooling of the cell is not always needed. However, when it is used it is advisable to take precautions against water leakage and to condensation inside and outside the cell.

Reducing the risk and effects of water leakage may be done in several ways.

Cooling water can be supplied directly from the laboratory tap if it has a fine and reliable valve or if such a valve is installed before the cell. If the water is supplied directly from a tap, ensure that there is no way to deliberately or undeliberately close the flowline after the cell. It may be necessary to reduce the flow or heat the water by some means to avoid the cell getting colder than the dew point of the gas flowing in it.

We suggest to consider to lead the water from the tap directly to the ceiling and openly down to the sink. Just before the turn at the top, make a branch to the cell from which a flow can run to the cell. This system lets all water go to the cell until there is enough flow to have overshoot, which it has a good capacity for. With this system you may place a fine valve at the end of the branch (after the cell, just before the sink) if the original tap is not fine enough. Several cells may be placed in series in the branch, but the length and complexity of the branch increase the chance for air-pockets that may stop the flow. It is advisable to have a high water fall in the branch of, say, 200 cm or more.

If tempered water or water as such is a problem, circulated water may be a better solution. An electrical pump and a storage tank may be suitable, but also pumping by a rising bubble column driven by pressurised air may be an option.

In many laboratories and instances, fan cooling is probably a better option than water cooling.

10.3 Gas mixer and gas handling

Flow control and mixing can be done with mass flow controllers or manual valves/rotameters.

Pressure control and overpressure relief can for instance be done with columns of dibutyl phthalate (or mineral oil), which is a liquid with the same density as water but with negligible vapour pressure. Be sure to equip the columns with volumes that can catch back-flow and forward bursts of liquid. Preferably organise these volumes such that the liquid pours back down by itself when conditions revert to normal. Note that dibutyl phthalate slowly attacks many types of polymers so that spillage onto floors, benches, plexi-glass windows, etc. must be washed off (it does not evaporate!). It may be kept in polyethylene bottles, though. After prolonged use with carbon monoxide it turns yellowish and brownish, but can still be used. We have used dibutyl phthalate with pure oxygen for many years without problems, but use may have to be checked against your local safety rules.

Drying gases may be done in many ways, e.g. by liquid nitrogen cooling or by professional filters with indicators. If you fill your own columns you may use e.g. microporous adsorbents (zeolites) or P_2O_5 . The latter should only be used on an inert substrate (sold commercially with or without indicator), which prevents formation of liquid phosphoric acid. Other chemicals such as NaOH and KOH are also effective, but will also take up CO_2 .

The above-mentioned desiccants typically give nominal water vapour levels of 1 ppm or lower (see below for note on actual level in ProboStat).

Many well-known desiccants such as $CaCl_2$, silica gel, and $CuSO_4$ give considerably higher levels and should be avoided unless you deliberately want to supply a certain, small pH_2O .

NOTE: While good desiccants give less than 1 ppm of water, many sources of water later in the gas line may increase this number considerably. Even a short length of polymer tubing can increase the level typically to 100 ppm. In our experience, ProboStat itself typically gives an effective pH_2O of 30 ppm at high temperatures, assigned to desorption from and diffusion through walls and seals. Lowering of this value may be considered possible by degassing, but should be checked.

Wetting may also be done in many ways, from advanced (commercial humidifiers) to simple (bubbling through water). One may use mixtures of solids with their solid hydrates to give fixed pH_2O with large capacity and possibility to vary pH_2O thermostatically. One may use phosphoric acid with a certain concentration, for which occasional refilling of water is necessary and pH_2O may be set by filling water to given volume marks. One may use a saturated solution of a salt, with excess salt. For instance, KBr gives ca. 80% RH around room temperature, so that the pH_2O can be calculated from the temperature and pH_2O over pure water. Other salts may be used which give other RH's. Some salts, like NH_4SO_4 , have considerable vapour pressures and should be avoided. Hydrogen-free salts such as KBr are also suitable for heavy water. Note that the vapour pressures over D_2O are slightly different from those over H_2O . For use of salt solutions, run the gas through or over pure water first, otherwise the inlet to the salt solution will clog as salt is precipitated. For bubbling stages one may use glass frits, but these give some gas hindrance, and equilibrium is fairly easily attained anyway at low gas flows. However, it is a good idea to use a cotton or glass wool or frit capture of gas droplets on the way out.

Intermediate and variable water vapour levels may be obtained by using different wetting stages and "desiccants", by varying the temperature of the wetting stage or by mixing wet and dry gas.

Humidity meters may be used to check wetting stages pH_2O in general. Simple ones cover only high values, in the 5-100 % RH range, while down into ppm ranges are available in more expensive models.

Calibration may not be straightforward and reliable, though, as it depends on the reliability of the same methods of wetting as we have described here.

NORECS manufactures and sells the following items for use with ProboStat (see special brochures or contact NORECS for more details):

ProGasMix: Full gas mixer with up to 16 manual rotameter-type flowmeters. The ProGasMix selects and mixes up to 3 gases from up to 7 input gases connected to the mixer, mixes the gases in ratios up to 1:100,000 to control e.g. pO_2 and additionally mixes wetted and dry portions of the mixture to control pH_2O . It can make 2 mixtures for use in transport number measurements, permeability tests, or fuel cell tests.

FCMix: This is a simple gas mixer for fuel cell tests with 3 input gases, intended for use with H_2 (or diluted H_2), air (or O_2) and one inert diluting gas (e.g. N_2 or Ar). It comes with 2 Probble humidifier and overpressure safeguard units.

Probble: Simple and safe plastic combined humidifier and overpressure control/safeguard unit.

10.4 Electrical characterisation instruments

To our knowledge, all standard impedance spectrometers and conductivity bridges, as well as potentiostats/galvanostats can be connected directly to the ProboStat via four of the BNC plugs.

10.5 Software

10.5.1 Software for running measurements

NORECS has developed its own control and plotting software, called Omega. Omega is a flexible measurement software for voltage, current, resistance, impedance, temperature or gas flow related measurements. It can measure but also control the instruments; ramp furnaces, manage gas mixing and apply currents. Experiments can be automated and actions, for example impedance sweeps, can automatically trigger at set conditions such as temperature or conductivity equilibrium.

Omega software is essential part of ProboStat systems that are sold with furnace and/or other equipment. The Omega software is also the only software on the market that can automate a measurement setup that includes multiple instruments from multiple separate suppliers, where all items of the equipment are interconnected.

10.5.2 Controlling temperature

Some of the instrumentation software packages can control temperature, including our own Omega and OmegaTemp, so as to ensure good integration between measurements and temperature control and reading. Also the temperature controller manufacturers make control programs (which are then more standalone and separate from data capture).

10.5.3 Analysing impedance spectra

We are using Equivalent Circuit from B. Boukamp at Univ. Twente and Omega software. Other programs are available.

10.5.4 Software for gas mixing

NORECS offers at present GasMix - a simple gas mixer program that emulates a gas mixer and calculates the as-mixed partial pressures of gas components as well as the equilibrium composition under given conditions. It is based on your pre-entered flowmeter calibration curves if needed and on manual input of

flowmeter readings. It does not control the gas mixer. It is specially designed for our ProGasMix mixer, but can be configured for many other mixers, and is especially valuable for rotameter-based ones.

10.5.5 Analysing conductivity, Seebeck coefficients, etc.

The measured dependency of conductivity on temperature, pO_2 , pH_2O , etc. may be fitted to solutions based on defect chemistry and transport mechanisms, whereby assumptions and models may be tested and parameters for the models obtained. For this we are presently using TableCurve 2D, for which model libraries may be developed and exchanged.

Senior scientist Finn Willy Poulsen of Risø National Laboratories, Denmark has made a series of Excel spreadsheets which calculate defect concentrations, conductivity, etc. for a number of defect models in oxides, and this may be useful for comparison with measured data in more qualitative way. The interested scientist is advised to contact the author.

11 Malfunctions and repairs - troubleshooting

Within the first year warranty we will repair or replace malfunctioning parts free of charge. After that we will take on repairs at regular prices. We will also take on modifications and sell accessories and consumable parts.

The following lists some malfunctions of ProboStat that may be anticipated with time, and suggestions for remedies or repairs.

11.1 Cooling water leakage

If cooling water sips out from the base unit (not from the hose contacts) there is a leakage in the water cooling O-rings interior to the base unit.

Check that there is free outlet for the cooling water.

If the screws that fasten the connector box to the base unit are loose, try to tighten them. Do not tighten too hard, as they do not tighten the O-rings, only hold the ring in place.

If the above does not help, you have to disassemble the water cooling cylinder, which is a considerable task. We recommend to send the base unit to us for repair, or contact us for advice.

11.2 Gas leakage

The most probable sources of gas leakage in the ProboStat are:

The enclosing tube O-ring seal: The remedy is first to tighten the ring a little. If necessary open it and inspect the O-ring for cracks or wear. Clean and slightly grease the surfaces. You may need to use an O-ring of slightly different dimensions (smaller and/or thicker) if the tube is too small.

The electrical feedthroughs: These are only mechanically sealed. If they become loose due to damage, they may leak, and sealing as described below or permanent replacement may become necessary. However, we suggest you do not glue them, as that will make replacement difficult. You may order new feedthroughs from us or send the base unit assembly to us for repair.

In order to improve the sealing of the PEEK or Torlon feedthroughs you may try the following:

Mount the cell upside down. If possible, pump vacuum on the cell and monitor the pressure if you can. Make a thin, readily flowing, solution of a polymer in a solvent, e.g. polyacrylate in ethyl acetate. Using a fine dispenser, apply a few drops of solution down into each feedthrough hole. The solvent will not harm the insulator, metal parts or the compensation cable insulation. If you hit a hole with a leak, the pressure will immediately drop, the polymer will get sucked into the leak, and seal it permanently upon drying. Allow drying of the solvent overnight.

O-rings in the quick-connects on the connector box: Perform maintenance and/or replace O-rings according to Swagelok procedures.

Cracks in the outer tube: Replace the tube.

If you are not able to locate a leakage by other means it may be possible to take a cell subjected to slight overpressure and submerge it fully or partially in water; a major leak will usually easily be seen by the emerging bubbles.

Leakages between the cell chambers are usually found in the sample seal itself or in the sealed sample not being 100% gas-tight due to porosity or cracks. Check also that the support tube O-ring below the support tube ring is intact.

After long-term use corrosive gases may attack the sealing between the gas tubes (in the connector box) and the base unit block. Also mechanical stress by loose parts may cause this. The sealing may be repaired temporarily by glue like Araldit™: Mount the cell upside down and remove both side plates. Apply glue around each gas tube where it enters the base unit block and let it cure.

11.3 Breakage in electrical leads

If you suspect that the electrical system is defective, check the contacts between each point on the terminals of the coax/BNC cables or thermocouple compensation cables and the corresponding point on the feedthroughs of the base unit, using a multimeter. Further, check that there is no contact between any of the same points, except where made in the connector box or by the shields bridge. For these tests, use Table 1 as guide. If a fault is found, disconnect the coax/BNC or thermocouple cables and locate the fault to the base unit or the cable.

If you conclude that a feedthrough is broken, replace it, or transfer its function to an unused one. Extra **male feedthrough assemblies** (male feedthrough contact, compensation cable and plastic insulation) may be ordered (in case of breakage) but are not straightforward to replace.

In versions A-3 and earlier, the leads in the connector box are fastened to the chassis multi-connector by screw-contacts in the case of the Phoenix rectangular contact. Check by pulling gently in each lead using a pincette or the small pliers. Fasten if required. Check/tighten all screws gently. Check the multi-cable Phoenix plug only if it is concluded that a breakage must be in the cable assembly. Opening the plug may easily do more harm than good. If the contacts in the plug are OK, the only option left is the BNC contact. The lead must be cut closest possible to the faulty or loose BNC plug and a new plug put on. This requires special tools and some expertise.

From version A-4, check solder of wires to BNC chassis connectors. If OK, check individual coax/BNC cables.

For the Amphenol circular multi-connector used in A-0, the wires are contacted by solder. However, the checking procedures are mainly the same – use a soldering iron instead of screwdriver for repairs.

11.4 Broken feedthrough (male) on the base unit

If a feedthrough is broken, you may replace it, or transfer its function to an unused one. Extra **male feedthrough assemblies** (male feedthrough contact, compensation cable and plastic insulation) may be ordered (in case of breakage).

We can deliver a kit of tools and parts needed for on-site repair/replacement of feedthroughs. Repairing of the broken feedthroughs for the high-temperature base unit is challenging. We recommend to send the base unit to us for repair, or contact us for advice.

11.5 Burning of parts on the base unit

If parts on the base unit show signs of oxidation or melting, consult the special chapter elsewhere in the manual for operation at very high temperatures.

11.6 Mechanical parts stuck

If the enclosing tube flange or support tube rings start becoming hard to turn, remove any dirt or foreign objects from the threads using e.g. a hard brush, and/or try to add a drop of oil to the thread.

11.7 *Seemingly erratic, random, or noisy measurements*

Check that you have installed the shields-bridge or turn the Shields bridge switch in the position Down if your impedance-measuring device requires it.

If readings of conductance or resistance are in reasonable ranges, but negative, it is likely that two or more wires have been mixed up.

If readings are noisy and/or random, it is possible that you have lost contact with one of the electrode contacts, or that one of the shields is broken, or that one wire is short-circuited to earth. The latter typically happens at the bottom of the hot-zone, where uninsulated wire passes the metal of the pedestal.

Also check the position of the switches. Normally the first (Ch+HCS) should be down as it includes the chassis of the ProboStat in the shielding system, and second should be up unless something at the LC connection should be grounded, as guard.

12 Instructions for fabrication of parts and samples

In the following, “alumina” means fully dense, pure alumina (99.7%), both Alsint 99.7 and AL23. SS means stainless steel.

NOTE: Not all parts of the ProboStat are properly included in this section in the present version of the manual. Contact us for updates or special instructions for production of such parts e.g. at post@norecs.com.

All measures given here are for standard cells (enclosing tube length – 60 cm). Use the appropriate measure for your cell if it is shorter than the standard cell (see chapter 14: Identification and Specification)!

All measures given here are for ProboStat A-6. In case of earlier versions, contact us for advice.

12.1 Instructions for fabrication of ceramic parts

12.1.1 Enclosing (outer) tubes

12.1.1.1 Parts and fabrication

Part	Material	Diameter	Length
Closed alumina tube	AL23	40 mm OD	60 cm
Closed quartz tube	Fused quartz	40 mm OD	60 cm
Closed SS tube	SS	40 mm OD	60 cm

OD = Nominal outer diameter of enclosing tube.

Alumina: Use a 40 mm outer Ø alumina tube, closed in one end.

Quartz: Use a 40 mm outer Ø tube. Close in one end (by order or by your own glass workshop).

Steel or other metal: Use a 40 mm outer Ø tube in a steel quality appropriate for the type of use, closed in one end by proper welding. Mount a water cooling cylinder directly onto the lower part (allowing space for the outer tube flange). Mount a proper earthing terminal onto the metal, to be connected to a proper Earth point.

Order or cut tubes to length 60 cm. Use the appropriate length for your cell if it is shorter than the standard cell!

The base unit tolerates inner diameters down to 33 mm and outer diameters up to 41 mm. This is rarely a problem for quartz or metal tubes. However, alumina tubes tend to vary in dimensions and may fall outside these tolerances. For new orders, check that tube is within our tolerances and, if in doubt, that it fits in the base unit and that the base unit outer flange fits on the outside. Alumina tubes also have a tendency of protrusions (droplets) on the inner walls. You can see these by visual inspection or by rotating a long thin alumina tube along the inside wall. Avoid using tubes with such protrusions. If you still need to use it, mark the radial position of the protrusion on the cold part of the tube, so that you later can try to avoid hitting the widest parts of the sample assembly.

12.1.2 Sample support tube assemblies for disk samples

12.1.2.1 Parts

Part	Material	Diameter	Length
Alumina tube	Alsint 99.7	10 mm OD	47.5 cm
Alumina tube	Alsint 99.7	12 mm OD	47.5 cm
Alumina tube	Alsint 99.7	15 mm OD	47.5 cm
Alumina tube	AL23	16 mm OD	47.5 cm
Alumina tube	Alsint 99.7	20 mm OD	47.5 cm
Alumina tube	Alsint 99.7	24 mm OD	47.5 cm
Support tube socket	M	D mm	-
Glue	Epoxy, auto-marine	-	-

M = Metal of base unit (B = Ni-plated brass, SS = Stainless steel), OD = Nominal outer diameter of support tube. Use the appropriate length for your cell if it is shorter than the standard cell!

If necessary, cut the alumina tube so that the total length from the free end to the lower rim of the support tube socket is 50.7 cm. (For the present design of the support tube sockets, this amounts to cutting the tube down to 47.5 cm before gluing, as listed also in the table.) Normally, use the cut end for gluing and keep the original end free. Anyway, ensure that the free end is flawless.

For sample support tubes with outer diameter of 20 mm or smaller, the support tube socket is to accommodate the tube inside, while for 24 mm diameter - the tube will fit on the outside of the socket.

For the gluing, we use a 2-component, heat resistant glue, like Epoxy, auto-marine (J-B Weld Co.).

12.1.2.2 Fabrication

Fix the support tube socket upright, e.g. on the cell pedestal itself. Check that the tube fits to the socket. Put glue on the sealing surfaces of both the socket and the tube. Be sure not to spill glue on sensitive parts of the support tube socket or base unit.

Put the tube in place.

Remove excessive glue and check that the tube is mounted straight, if possible by rotating the support tube socket.

Correct the angle if necessary by some kind of support until the glue is hardened.

12.1.3 Sample support tube assembly for bar samples

12.1.3.1 Parts

Part	Material	Diameter	Length
Alumina tube	AL23	20 mm OD	47.5 cm
Support tube socket	M	D mm	-
Glue	Epoxy, auto-marine	-	-
Alumina rod	AL23	12(-15) mm	4 and 5.5 cm
Alumina disk	AL23	20 mm	-

M=Metal of base unit (B=Ni-plated brass, SS=Stainless steel), D=Nominal outer diameter of support tube.

12.1.3.2 Fabrication of the tube assembly

In one end, cut or machine out a slit window that covers 120° of the circumference, starts 2.4 cm from the end, and is 5.3 cm long. In the lower end widen the cut 2 mm on each side with a height of ca. 3.5 mm.

If necessary, cut the alumina tube in the un-machined end so that the total length from the upper end to the lower rim of the support tube socket is 50.7 cm. (For the present design of the support tube sockets, this amounts to cutting the tube down to 47.5 cm before gluing, as listed also in the table.). Use the appropriate length for your cell if it is shorter than the standard cell!

For the gluing, we use a 2-component, heat resistant glue, like Epoxy, auto-marine (J-B Weld Co.).

Fix the support tube socket upright, e.g. on the cell pedestal itself. Check that the tube fits to the socket. Put glue on the sealing surfaces of both the socket and the tube. Be sure not to spill glue on sensitive parts of the support tube socket or base unit.

Put the tube in place.

Remove excessive glue and check that the tube is mounted straight, if possible by rotating the support tube socket.

Correct the angle if necessary by some kind of support until the glue is hardened.

12.1.3.3 Fabrication of roof and floor

For the roof, cut if necessary a 12-15 mm diameter alumina solid rod to a length of 4.0 cm and 5.5 cm lengths to cover samples of varying length.

For the floor, use a 20 mm diameter, 3 mm thick solid alumina disk. Cut off a small arc, 3 mm deep, and check/adjust to make it fit as a floor in the bar support tube slit.

12.1.4 Inner gas tubes

12.1.4.1 Parts and fabrication

Part	Material	Diameter	Length
Alumina tube 4 mm	Alsint 99.7	4 mm OD	47 cm*
Alumina tube 3 mm	AL23	3 mm OD	47 cm*
Alumina tube, multibore 8.5 mm	AL23	8.5 mm OD	43.5 cm
Silicone hose	Silicone rubber	3x5 mm	3.2 cm
		(ID×OD, for 4 mm tube) 2x4 mm (for 3 mm tube)	2.0 cm*

Inner gas tubes are used in 8.5 mm (multibore) or 4 or 3 mm (tube) versions.

For sample support tubes with outer diameters 10 or 12 mm, 3 mm tube is recommended. For support tubes with 20 or 24 mm outer diameter, multibore tube is recommended for applications where broad contact area and current collection is needed. The ProboStat A-6 is equipped with changeable gas stubs. For ProboStats that are delivered with support tubes with outer diameter between 10 and 16 mm, the stubs are shorter than for systems based on support tubes with outer diameter 20 – 24 mm. The length of gas tubes and silicone for use with short stubs are marked with *.

Order or cut the alumina tube to correct length. Use the appropriate length for your cell if it is shorter than the standard cell!

The multibore tube has to be glued onto a PEEK socket. Use a 2-component, heat resistant glue, like Epoxy, auto-marine (J-B Weld Co.). Put glue on the sealing surfaces of both the socket and the tube. Be sure not to use too much glue, so as the small gas holes are blocked. Place the tube in the upright position

with the socket on top until the glue is hardened. Secondly, turn it the opposite way and seal the connection, tube and socket. Let the glue harden.

Cut silicone hose to length 3.2 cm (2.0 cm*).

Thread silicone hose 0.5 cm onto the alumina tube, alternatively as far as possible when the multibore tube is used.

12.1.4.2 Mounting

Thread the alumina tube by the free end of the silicone hose onto the centre tube of the pedestal of the base unit.

If used in an emf-type or other measurement where you need to contact a centre lower electrode, you may use the inner gas tube to press contact leads onto that electrode. In that case, adjust the length of the silicone hose so that the tube is perfectly aligned with the support that the sample rests on, be it a support tube or a support disk with a centre hole. For the latter you may need to retract the hose thread a little from the pedestal's inner gas tap or from the alumina gas supply tube or both. For more details, see the centre electrode connections.

12.1.4.3 Use

The inner gas tube may flush gas directly onto the sample from below, or extract gas from the lower electrode. As mentioned above, it may also function to press leads in contact with a centre electrode.

12.1.5 Outer straight gas tubes

12.1.5.1 Parts and fabrication

Part	Material	Diameter	Length
Alumina tube 4 mm	AL23	4 mm OD	48 cm
Alumina tube 3 mm	AL23	3 mm OD	48 cm
Silicone hose	Silicone rubber	3x5 mm (ID×OD)	4 cm

Use a 4 or 3 mm outer Ø alumina tube. In combination with 24 mm outer Ø support tube, 3 mm outer Ø gas tube is recommended.

Cut the alumina tube to length 48 cm if necessary. Use the appropriate length for your cell if it is shorter than the standard cell!

Cut silicone hose to length 4 cm.

Thread silicone hose 0.5 cm onto the alumina tube.

12.1.5.2 Mounting

Thread the alumina tube by the free end of the silicone hose onto the gas inlet tube of the outer chamber of the base unit.

12.1.5.3 Use

The outer straight gas tube may flush gas to the outer chamber, but does not hit the upper electrode of a disk sample directly.

12.1.6 Outer bent gas tubes

12.1.6.1 Parts and fabrication

Part	Material	Diameter	Length
Quartz tube 4 mm	Quartz	4 mm OD	60 cm start, 50.6 cm tip-to-tip final (see text)
Quartz tube 3 mm	Quartz	3 mm OD	60 cm start, 50.6 cm tip-to-tip final (see text)
Silicone hose	Silicone rubber	3x5 mm (ID×OD)	2.5 cm

Use a ca. 60 cm long, 4 or 3 mm outer diameter quartz tube. Make a bend of ca. 2 cm from what will become the short end. The width of the bend must be such that the distance from the centre of the short end to the nearest surface of the long end is 11 ± 0.5 mm.

Cut the long end 50.6 cm from the tip of the short end. Use the appropriate length for your cell if it is shorter than the standard cell!

Cut a 3x5 mm silicone hose to a length of 2.5 cm. Thread 0.5 cm onto the quartz tube.

At the time of assembly in the cell, thread 1-2 mm of hose onto the gas inlet tap. Then lift the short end above the rim of the spring load top plate and let it point down into the centre hole. Slide the hose further down on the tap so that the short end remains safely within the centre hole. However, do not let it touch the sample, and leave ca. 3 mm extra space: This is needed because the alumina expands during heating, while the silica doesn't.

12.1.7 Outer bent gas tube for wide samples (24 mm support).

In order to have enough space you may have to use the 3 mm quartz tube. Make it as described above with respect to lengths. However, the width of the bend has to accommodate the larger width of the sample and support assembly: Make the bend such that there is 13 ± 0.5 mm from the centre of the short end to the nearest surface of the long end.

12.2 Instructions for fabrication of spring load assemblies

12.2.1 Spring load assembly, standard

12.2.1.1 Parts

1 pcs of pre-machined alumina triangular plate. **Ordered from us.**

3 pcs of 46 cm long, 4 mm outer Ø alumina tubes. Use the appropriate length for your cell if it is shorter than the standard cell!

3 pcs of 2 mm outer Ø, 8 mm long alumina tubes.

3 pcs of 2.5 cm wire in thickness 0.5 mm made of Pt or Pt+Rh alloy.

3 steel springs of 3-4 mm diameter, ca. 20 mm length. The spring stiffness and length may be adjusted to fit the strength of the sample, the need for sealing power, and the technique of the user. It is normally not necessary to use special heat tolerant alloys – the temperature experienced by the springs will not be too high. However, stain-resistant steel is advisable if the gases used are going to be wet and/or acidic. Standard springs may be ordered from us.

12.2.1.2 Procedures

Tubes:

Cut each tube to a length of 46 cm if necessary. Drill a 2.5 mm hole in each end of the tube, approximately 2 mm from the end.

Locking tubes:

Cut the thin locking tube alumina to a length of 8 mm.

Fixing Pt wire:

Cut 3 x 2.5 cm length of 0.5 mm thick Pt wire.

Springs:

Cut a spring to a length of ca. 20 mm. Use small pliers to extract an “eye” in each end suitable for hooking onto the base unit pedestal groove and the lower end of the spring load bars.

Increase the lengths to decrease the spring force or adjust for higher sample assemblies. Decrease the lengths to increase the spring force, or use stiffer steel.

12.2.1.3 Assembly/mounting

No more assembly is done before actual use.

Mounting for actual use:

Thread a small length (2.5 cm) of 0.5 mm Pt wire through the locking tube. Thread the locking tube with wire through the hole in the long tube, and lock the Pt ends by inserting them down the top of the long tube. Thread the tubes through the holes in the top plate; let the locking tube rest on the top plate.

Hook the springs into the lower holes of the spring load tubes.

Slide the assembly down over the sample on the support. Press the top plate towards the sample while hooking the springs into the groove under the pedestal rim.

NOTE 1: This is a fairly difficult operation, especially if you attempt to combine a strong spring force with a fragile sample. In addition to breakage of the sample, inexperience may also lead to breakage of the spring load tubes. We thus recommend to practice using dummy samples, e.g. a 2 cm diameter alumina disk (supplied with the cell).

NOTE 2: The procedure above does not include the positioning of electrode contacts between the sample and the spring load top plate. This may be done before or after the mounting of the spring load assembly. Both methods have their advantages and difficulties.

A complete sample assembly may contain many elements sandwiched under the spring load. After assembly, check that:

Bottom electrode compression force is not stronger than the top force so that the sample is lifted from the support.

Sealing gasket or guard/reference ring electrode contact is in place.

Electrode contacts are in place.

In addition you must check that electrode contacts are properly connected and not shorted. This is described elsewhere.

An unstable or otherwise doubtful assembly may do the job, but it is difficult to know until you disassemble the cell whether it has actually been OK. Thus, it is best to work on an assembly until you are satisfied.

We recommend documenting the setup and assembly by photographing it before closing the cell.

12.2.2 Spring load assembly for van der Pauw setup

12.2.2.1 Parts

2 pcs of 46 cm long, 4 mm outer Ø alumina tubes. Use the appropriate length for your cell if it is shorter than the standard cell!

1 pcs of 2 mm outer Ø, 30 mm long alumina tube.

2 pcs of 4 mm outer Ø, 20 mm long alumina tube.

2 steel springs. They should be of 3-4 mm diameter, ca. 20 mm long. The spring force constant and length of the spring may be adjusted to fit the strength of the sample and the technique of the user. It is normally not necessary to use special heat tolerant alloys – the temperature experienced by the springs will not be too high. However, stain-resistant steel is advisable if the gases used are going to be wet/and or acidic. Standard springs may be ordered from us.

12.2.2.2 Procedures

Tubes

Cut each tube to a length of 46 cm if necessary. Drill a 2.5 mm hole in each end of the tube, approximately 2 mm from the end.

Bridging tube

Cut the 2 mm thin bridging alumina tube to a length of 28 - 30 mm. 28 mm makes in line with the support tubes, i.e. a narrow assembly, while 30 mm more safely penetrates the spring load tubes, but at the cost of a broader assembly.

Contact tubes

Cut the 4 mm alumina tubes to lengths of 20 mm. Drill a central hole of 2.5 mm diameter. On each side of this, 15 mm apart, drill smaller holes of 1.5-2.0 mm diameter. This will be suitable for fitting van der Pauw point electrode contacts symmetrically at the rim of a 20 mm diameter sample. Since the van der Pauw electrodes may be applied also asymmetrically the same distance of holes can be used also for other sample dimensions, by moving the contact tubes along the bridging tube. However, additional holes of different distance may of course give more flexibility and symmetry for smaller or larger samples.

Springs

Cut a spring to a length of ca. 20 mm. Use small pliers to extract an “eye” in each end suitable for hooking onto the base unit pedestal groove and the lower end of the spring load bars.

Increase the lengths to decrease the spring force or adjust for higher sample assemblies. Decrease the lengths to increase the spring force, or use stiffer steel.

12.2.2.3 Assembly/mounting

In order to use the assembly, you need four electrode contacts. Their fabrication is described elsewhere.

12.2.3 Spring load assembly for wide samples

12.2.3.1 Parts

1 pcs of pre-machined alumina triangular plate for wide sample. **Ordered from us.**

3 pcs of 46 cm long, 4 mm outer Ø alumina tubes. Use the appropriate length for your cell if it is shorter than the standard cell!

3 pcs of 2 mm outer Ø, 8 mm long alumina tubes.

3 pcs of 2.5 cm wire in thickness 0.5 mm made of Pt or Pt+Rh alloy.

3 steel springs of 3-4 mm diameter, ca. 20 mm length. The spring stiffness and length may be adjusted to fit the strength of the sample, the need for sealing power, and the technique of the user. It is normally not necessary to use special heat tolerant alloys – the temperature experienced by the springs will not be too high. However, stain-resistant steel is advisable if the gases used are going to be wet and/or acidic. Standard springs may be ordered from us.

12.2.3.2 Procedures

Tubes:

Cut each tube to a length of 46 cm if necessary. Drill a 2.5 mm hole in each end of the tube, approximately 2 mm from the end.

Locking tubes:

Cut the thin locking tube alumina to a length of 8 mm.

Fixing Pt wire:

Cut 3 x 2.5 cm length of 0.5 mm thick Pt wire.

Springs:

Cut a spring to a length of ca. 20 mm. Use small pliers to extract an “eye” in each end suitable for hooking onto the base unit pedestal groove and the lower end of the spring load bars.

Increase the lengths to decrease the spring force or adjust for higher sample assemblies. Decrease the lengths to increase the spring force, or use stiffer steel.

12.2.3.3 Assembly/mounting

No more assembly is done before actual use.

Mounting for actual use:

Thread a small length (2.5 cm) of 0.5 mm Pt wire through the locking tube. Thread the locking tube with wire through the hole in the long tube, and lock the Pt ends by inserting them down the top of the long tube. Thread the tubes through the holes in the top plate; let the locking tube rest on the top plate.

Thread all three alumina spring load tubes onto the triangle. Slide the top plate and the tubes+wire assembly down over the support. Check that the triangle does not hold the tubes too tightly or loosely. If too tight the tubes may break when forced straight. Adjust if necessary.

Hook the springs into the lower holes of the spring load tubes.

For final mounting, slide assembly down over sample on support. Press the top plate towards the sample while hooking the springs into the groove under the pedestal rim.

NOTE 1: This is a fairly difficult operation, especially if you attempt to combine a strong spring force with a fragile sample. In addition to breakage of the sample, inexperience may also lead to breakage of the spring load tubes. We thus recommend to practice using dummy samples, e.g. a 2 cm diameter alumina disk (supplied with the cell).

NOTE 2: The procedure above does not include the positioning of electrode contacts between the sample and the spring load top plate. This may be done before or after the mounting of the spring load assembly. Both methods have their advantages and difficulties.

A complete sample assembly may contain many elements sandwiched under the spring force. After assembly, check that:

Bottom electrode compression force is not stronger than the top force so that the sample is lifted from the support.

Sealing gasket or guard/reference ring electrode contact is in place.

Electrode contacts are in place.

In addition you must check that electrode contacts are properly connected and not shorted. This is described elsewhere.

An unstable or otherwise doubtful assembly may do the job, but it is difficult to know until you disassemble the cell whether it has actually been OK. Thus, it is best to work on an assembly until you are satisfied in the first place.

We recommend to document the setup and assembly by photographing it before closing the cell.

12.2.4 Spring load assemblies with Kanthal wire

All earlier mentioned spring load assemblies can be made using Kanthal resistance wire (e.g. 1 mm diameter) instead of alumina. The wire is more robust, but may not be used to as high temperatures. Signs of wire corrosion and chromium evaporation may start to appear at 1100°C and above and we suggest this is the upper limit of use.

When used in three-wire assemblies we suggest that eyes are formed in each end to hold the spring in one and a stopper for the top plate/holder for the small locking tube in the other. We suggest that a triangle (when used in combination with alumina top plate) is formed in Kanthal wire and used as a stopper for all three wires (similar to that described in platinum before).

Cut Kanthal wires to app. 47 cm, make an “eye” at both end of each wire.

When a two-wire Kanthal spring load assembly is used with a van der Pauw setup we suggest to use a one-piece Kanthal wire threaded through the bridge bar. Use a 3 mm OD rather than the 2 mm bridge bar for this, and make it only 22 mm long (for a 20 mm sample). Instead of putting the bridge bar through the centre holes in the contact bars, lay the contact bars 90 degrees over and lay the bridge bar over them, resting into the hole carving.

Cut 95 cm Kanthal wire, thread wire through bridge bar and bend it to the correct form and make an “eye” at each end of the wire.

For use of Kanthal wire for liquid sample measurements (assuming a short -30 cm cell), cut the wire to 59 cm. Make a sharp U-form at the midpoint of the wire by bending it over the length of a 30 mm alumina tube. Thread a 15 cm high temperature shrink tube onto the wire to cover the middle part, and heat it up. Then make an eye in each end of the wire for hooking the springs.

12.3 Instructions for fabrication of thermocouple assemblies

12.3.1 General

12.3.1.1 Materials and equipment

The following instructions are valid for a standard cell using **type S (Pt/Pt10Rh) thermocouples**. Use the appropriate wires if your cell was shipped with a different type of thermocouple! Use wires and tubes of the appropriate length for your cell if it is shorter than the standard cell!

For each thermocouple you need:

Alumina capillary tube, 2-bore, 3 mmØ, 50 cm long or ordered to length

Pt wire, 0.5 mmØ, thermocouple grade

Pt10Rh wire, 0.5 mmØ, thermocouple grade

2 female feedthrough connectors, 22 AWG

Insulation:

Red (Pt, -) and black (PtRh, +)

or

Blue (Pt, -) and white (PtRh, +)

or

White (Pt, -) and Orange (PtRh, +)

or

White (Pt, -) and Red (PtRh, +)

(or other colour codes if you are using a thermocouple different from the S or R types).

In addition you need:

Flat-nosed pliers

Welding equipment

Solder iron

Solder tin

Tape measure or other length measure

Lab stand with test-tube or burette grip.

You may also have good use of the multi-purpose template bar if available.

In order to check the polarity of the assembly you need a heat source (solder iron, hot air gun, or flame) and a DC voltmeter with mV range.

12.3.1.2 General procedures

In order to prevent contamination of samples, always wash your hands before working with parts that are to touch samples or otherwise will be present in the hot parts of the cell. Preferably wear gloves. We suggest you wash the exterior of parts after assembly using e.g. a suitable cloth and pure alcohol.

After assembly, check the polarity: Heat the tip of the thermocouple while measuring the terminal voltage. The PtRh should become significantly positive. If you use the solder iron for this purpose, do not touch directly the thermocouple with the tool, and also ensure that the voltmeter can measure 0.1 mV's or better to detect the small heating obtained in this case.

12.3.2 Thermocouple assembly for disk sample, top (TCT/D)

12.3.2.1 Procedure

The following instructions are valid for a standard cell using **type S (Pt/Pt10Rh) thermocouples**. Use the appropriate wires if your cell was shipped with a different type of thermocouple!

Cut alumina tube if necessary to 48.5 cm.

You may drill a hole for the thermocouple weld point in the tip of the tube, using a small diamond ball bore.

Thread Pt and Pt10Rh in the tube.

Weld.

Cut the wires to 57 cm.

Solder to connectors.

Insulate all but 1 cm.

Check that Pt10Rh is positive upon heating the tip, as described above.

This thermocouple now has a free tip which is used to bend over the triangular spring load plate.

12.3.3 Thermocouple assembly for disk sample, inner (TCI/D)

This thermocouple was a separate item in ProboStat version A-0. In ProboStat versions A-1 and above it is now identical to the TCC/B thermocouple.

12.3.4 Thermocouple assembly for disk sample, control (TCC/D)

12.3.4.1 Procedure

The following instructions are valid for a standard cell using **type S (Pt/Pt10Rh) thermocouples**. Use the appropriate wires if your cell was shipped with a different type of thermocouple!

Use alumina in length 50 cm.

You may drill a hole for the thermocouple weld point in the tip of the tube, using a small diamond ball bore.

Thread Pt and Pt10Rh in the tube.

Weld.

Cut the wires to 53.2 cm.

Solder to connectors.

Insulate all but 1 cm.

Check that Pt10Rh is positive upon heating the tip, as described above.

If the support tube size and other dimensions of your setup allow you may cover this thermocouple with the closed 15 cm long, 6 mmØ outer, 4 mmØ inner alumina cap.

12.3.5 Thermocouple assembly for bar sample, control (TCC/B)

12.3.5.1 Procedure

The following instructions are valid for a standard cell using **type S (Pt/Pt10Rh) thermocouples**. Use the appropriate wires if your cell was shipped with a different type of thermocouple!

Cut alumina tube if necessary to 46 cm.

You may drill a hole for the thermocouple weld point in the tip of the tube, using a small diamond ball bore.

Thread Pt and Pt10Rh in the tube.

Weld.

Cut the wires to 48 cm.

Solder to connectors.

Insulate 1 cm.

Check that Pt10Rh is positive upon heating the tip, as described above.

If the support tube size and other dimensions of your setup allow you may cover this thermocouple with the closed 15 cm long, 6 mmØ outer, 4 mmØ inner alumina cap.

12.3.6 Thermocouple assembly for bar sample, bottom (TCB/B)

12.3.6.1 Procedure

The following instructions are valid for a standard cell using **type S (Pt/Pt10Rh) thermocouples**. Use the appropriate wires if your cell was shipped with a different type of thermocouple!

Cut alumina tube if necessary to 38 cm.

Thread Pt and Pt10Rh in the tube

Weld.

Cut wires to 42 cm.

Solder to connectors.

Insulate 0.5 cm.

Check that Pt10Rh is positive upon heating the tip, as described above.

This thermocouple now has a 2-3 cm free tip which is used to bend over the floor plate and under the standing bar sample.

12.3.7 Thermocouple assembly for bar sample, top (TCT/B)

12.3.7.1 Procedure

The following instructions are valid for a standard cell using **type S (Pt/Pt10Rh) thermocouples**. Use the appropriate wires if your cell was shipped with a different type of thermocouple!

Cut alumina tube if necessary to 47 cm.

Thread Pt and Pt10Rh in the tube

Weld.

Cut wires to 52 cm.

Solder to connectors.

Insulate 0.5 cm.

Check that Pt10Rh is positive upon heating the tip, as described above.

This thermocouple now has a 3-4 cm free tip which is used to position it at the top face of a standing bar sample.

12.4 Instructions for fabrication of electrode contact assemblies

12.4.1.1 General equipment needed

For these assemblies you will need

alumina capillary tube, 2-bore, 3 mmØ, 50 cm long or ordered to length
or

alumina capillary tube, 1-bore, 2 mmØ, 50 cm long or ordered to length
or

alumina capillary tube, flat, 2-bore, 3x1.5mm, 40 cm long

female feedthrough connectors, 22 AWG

or

HV female feedthrough connectors, 20 AWG

Flat-nosed pliers

Solder iron

Solder tin

Tape measure or other length measure
Lab stand with test-tube or burette grip.

You may also have good use of the multi-purpose template bar if available.

12.4.1.2 General procedures

In order to prevent contamination of samples, always wash your hands before working with parts that are to touch samples or otherwise will be present in the hot parts of the cell. Preferably wear gloves. We suggest you wash the exterior of parts after assembly using e.g. a suitable cloth and pure alcohol.

12.4.2 Electrode "hand" contact assembly, outer, 2-wire (H2N#, # - diameter of Pt net disk)

12.4.2.1 Materials

Alumina capillary tube, 2-bore, 3 mm \varnothing , 50 cm
Pt wire, 0.5 mm \varnothing , 115.7 cm
(Pt net with diameter as outer diameter of the support tube, or as desired)
2 female feedthrough connectors

12.4.2.2 Procedure

Cut 115.7 cm Pt wire.

Use alumina capillary tube in length 50 cm.

Thread wire through one hole of alumina tube and enough that 1.5 cm protrudes.

Place tube and wire on the template bar so that the threaded end is 55.1 cm from the centre of the stud formation.

Thread the wire over the stud formation in the given "hand" or other desired pattern.

While threaded over the stud formation, thread the free end of the wire through the other hole of the alumina tube.

Loosen from the stud formation.

Place hand between two steel pistons and hold with hands. Twist wires twice close to the pistons.

Align and cut wire ends to same length.

Place the two feedthrough sockets, with brass-coloured (wire) end up, in two next-neighbour holes in the multi-purpose template bar.

Place the two Pt wire ends in the two sockets, and support with the test-tube/burette grip.

With the solder iron, heat both wire and socket. Apply solder tin and let it float down into the socket until it wets the socket's inside and outside as well as the Pt wire. Do not move wire until tin is solidified.

Repeat for the other wire.

Check for visual signs of dry-soldering, and reapply heat and solder tin if it appears necessary.

Remove assembly and place electrode contact area "hand" (with Pt net covering the hand) between (clean) steel pistons in a hydraulic press, such that at least 1.5 cm from the centre of the electrode formation is pressed.

Press at 5 metric tons in a hydraulic press for a few seconds.

Then move the hand to cover the twisted area and press once more at 3 tons.

Heat the flattened area in order to soften the Pt.

Check that Pt formation looks OK.

12.4.2.3 Package and storage

Pack or store assembly as it is, i.e. without bending the electrode contact.

12.4.2.4 Assembly

Bend 90° 1.1 cm from the centre of the electrode contact formation.

Contact to HV (13) and HC (15), or LV (8) and LC (6) depending on use.

Adjust height to account for sample thickness by bending wires at bottom and top if necessary.

Check that wires do not touch base unit block.

12.4.2.5 Use

Use as electrode contact to top electrode of disk samples, or as contact to lower electrode in case of disk sample resting on alumina plate on top of support tube.

12.4.3 Electrode "hand" contact assembly, outer, 1-wire, HV-version (H1N10HV)

Alumina tube, 1-bore, 2 mmØ, 48 cm
Pt wire, 0.5 mmØ, 59 cm
(Pt net 10 mm diameter)
1 HV female feedthrough connector

12.4.3.1 Procedure

Use alumina in length 48 cm.

Thread wire. Place tube and wire on the template bar with the shortest tube and excessive wire towards the stud formation "hand". Let the wire stop at 53 cm from the centre of the hand. Thread the excess wire over the stud formation in the given or desired pattern. Cut wire at return from hand.

Loosen from the stud formation.

Place the HV-feedthrough socket, with brass-coloured (wire) end up, in a hole in the multi-purpose template bar.

Place the Pt wire end in the socket, and support with the test-tube/burette grip.

With the solder iron, heat both wire and socket. Apply solder tin and let it float down into the socket until it wets the socket's inside and outside as well as the Pt wire. Do not move wire until tin is solidified.

Check for visual signs of dry-soldering, and reapply heat and solder tin if it appears necessary.

Remove assembly and place electrode contact area "hand" (with Pt net covering the hand) between (clean) steel pistons in a hydraulic press, such that at least 1.5 cm from the centre of the electrode formation is pressed.

Press at 5 metric tons for a few seconds.

Heat the flattened area in order to soften the Pt.

Check that Pt formation looks OK.

12.4.4 Electrode "hand" contact assembly, outer, 1-wire, top (H1TN10)**12.4.4.1 Materials**

Alumina tube, 1-bore, 2 mmØ, 47 cm
Pt wire, 0.5 mmØ, ~ 57.5 cm
(Pt net 10 mm diameter)
1 female feedthrough connector

12.4.4.2 Procedure

Cut alumina capillary tube if necessary to 47 cm.

Thread wire.

Place tube and wire on the template bar with excessive wire towards the stud formation "hand". Let the wire stop at 51.5 cm from the centre of the hand. Thread the excess wire over the stud formation in the given or desired pattern. Cut wire at return from hand.

Loosen from the stud formation.

Place the feedthrough socket, with brass-coloured (wire) end up, in a hole in the multi-purpose template bar.

Place the Pt wire end in the socket, and support with the test-tube/burette grip.

With the solder iron, heat both wire and socket. Apply solder tin and let it float down into the socket until it wets the socket's inside and outside as well as the Pt wire. Do not move wire until tin is solidified.

Check for visual signs of dry-soldering, and reapply heat and solder tin if it appears necessary.

Remove assembly and place electrode contact area "hand" (with Pt net covering the hand) between (clean) steel pistons in a hydraulic press, such that at least 1.5 cm from the centre of the electrode formation is pressed.

Press at 5 metric tons for a few seconds.

Heat the flattened area in order to soften the Pt.
Check that Pt formation looks OK.

12.4.4.3 Package and storage

Pack or store assembly as it is, i.e. without bending the electrode contact.

12.4.4.4 Assembly

For 20 mmØ support tubes: Bend 90° 1.1 cm from the centre of the electrode contact formation.
Contact to HV (13) or HC (15) depending on use.
Adjust height to account for sample thickness by bending wires at bottom and top if necessary.
Check that wires do not touch base unit block.

12.4.4.5 Use

Use as electrode contact to top electrode of bar samples.

12.4.5 Electrode "hand" contact assembly, outer, 1-wire, bottom (H1BN10)

12.4.5.1 Materials

Alumina tube, 1-bore, 2 mmØ, 42 cm (or 40 cm)
Pt wire, 0.5 mmØ, ~ 52 cm
(Pt net 10 mm diameter)
1 female feedthrough connector

12.4.5.2 Procedure

Cut alumina capillary tube if necessary to 42 cm (or 40 cm).

Thread wire.

Place tube and wire on the template bar with excessive wire towards the "hand". Let the wire stop at 46.2 cm from the centre of the "hand". Thread the excess wire over the stud formation in the given or desired pattern. Cut wire at return from hand.

Loosen from the stud formation.

Place the feedthrough socket, with brass-coloured (wire) end up, in a hole in the stud formation bar.

Place the Pt wire end in the socket, and support with the test-tube/burette grip.

With the solder iron, heat both wire and socket. Apply solder tin and let it float down into the socket until it wets the socket's inside and outside as well as the Pt wire. Do not move wire until tin is solidified.

Check for visual signs of dry-soldering, and reapply heat and solder tin if it appears necessary.

Remove assembly and place electrode contact area "hand" (with Pt net covering the hand) between (clean) steel pistons in a hydraulic press, such that at least 1.5 cm from the centre of the electrode formation is pressed.

Press at 5 metric tons for a few seconds.

Heat the flattened area in order to soften the Pt.

Check that Pt formation looks OK.

12.4.5.3 Package and storage

Pack or store assembly as it is, i.e. without bending the electrode contact.

12.4.5.4 Assembly

Bend 90° 1.1 cm from the centre of the electrode contact formation.

Contact to LV (8) or LC (6) depending on use.

Adjust height to account for sample thickness by bending wires at bottom and top if necessary.

Check that wires do not touch base unit block.

12.4.5.5 Use

Use as electrode contact to bottom electrode of bar samples.

12.4.6 Electrode contact assembly, inner, 2-wire (IN2)

For 10, 12 and 15 mm sample support tubes.

12.4.6.1 Materials

Alumina capillary tube, 2-bore **flat**, 45 or 40+5 cm

Pt wire, 0.5 mmØ, 98.5 cm.

2 female feedthrough contacts

12.4.6.2 Procedure

Cut 98.5 cm Pt wire.

Cut alumina capillary tube if necessary to 45 cm.

Thread the wire ends through both holes of the alumina tube from same side, enough that 2.5 cm protrudes on both wire ends.

Place the two feedthrough sockets, with brass-coloured (wire) end up, in two nearest holes in the multi-purpose template bar.

Place the two Pt wire ends in the two sockets, and support with the test-tube/burette grip.

With the solder iron, heat both wire and socket. Apply solder tin and let it float down into the socket until it wets the socket's inside and outside as well as the Pt wire. Do not move wire until tin is solidified.

Repeat for the other wire.

Check for visual signs of dry-soldering, and reapply heat and solder tin if it appears necessary.

On the high-temperature end, narrow in the closed Pt wire loop to a distance of 1-2 mm.

12.4.6.3 Package and storage

Pack or store assembly as it is, i.e. without bending the electrode contact.

12.4.6.4 Mounting

Use a 3 or 4 mm inner gas supply tube. Install and adjust height of inner gas supply tube to be perfectly aligned with the top of the sample support, as described elsewhere. Remove support (sample support tube, and disk, if used).

Contact electrode connection pair to ILC (3) and ILV (4).

Without inserting into the gas supply tube, make a 180° bend in the Pt wire pair, so that will accurately fit over the edge of the gas supply tube.

Lift the electrode connection pair off the feedthroughs, and reinsert it, but this time letting the electrode connection pair tip slide into the gas supply tube.

Remount support(s) and check that electrode pair bend just extends over the support. Check also that the platinum can be easily pressed down into alignment with the support by for instance a sample disk.

Be sure that the lower end of the alumina capillary does not reach beyond the upper end of the silicone hose of the inner gas supply tube – the two together may be too wide.

Collect the electrode insulation and wire very straight and close to the gas supply tube. Screw on the support tube very carefully – the space inside is very limited. If there is a tendency for the electrode to catch and follow around, stop before the feedthroughs are destroyed.

12.4.6.5 Use

Use as electrode contact to lower, centre electrode of disk samples.

12.4.7 Electrode “hand” contact assembly, inner, 2-wire (INH2N12)

For 20 or 24 mm sample support tubes in combination with multibore gas tube.

12.4.7.1 Materials

Alumina capillary tube, 2-bore **flat**, 40 cm
Pt wire, 0.5 mmØ, 105.5 cm
(Pt net 12 mm diameter)
2 female feedthrough contacts

12.4.7.2 Procedure

Cut 105.5 cm Pt wire.

Cut alumina capillary tube if necessary to 40 cm.

Thread wire through one hole of the alumina tube and enough that 4 cm protrudes. Place tube and wire on the template bar so that the threaded end is 49.2 cm from the centre of the stud formation.

Thread the wire over the stud formation in the given “hand” or desired pattern. Let the middle “finger” be 1.0 cm longer than normal. While threaded over the stud formation, thread the free end of the wire through the other hole of the alumina tube. Press the long finger as thin as possible.

Loosen from the stud formation.

Align and cut to same length as the other end.

Place the two feedthrough sockets, with brass-coloured (wire) end up, in two next-neighbour holes in the multi-purpose template bar.

Place the two Pt wire ends in the two sockets, and support with the test-tube/burette grip.

With the solder iron, heat both wire and socket. Apply solder tin and let it float down into the socket until it wets the socket's inside and outside as well as the Pt wire. Do not move wire until tin is solidified.

Repeat for the other wire.

Check for visual signs of dry-soldering, and reapply heat and solder tin if it appears necessary.

Remove assembly, press the middle finger further together and bend nearly the whole finger for 90°.

Place electrode contact area with Pt net covering the hand between (clean) steel pistons in a hydraulic press, such that the middle finger placed in the centre hole of a piston.

Press at 5 metric tons for a few seconds.

Check that Pt formation looks OK.

Heat the flattened area in order to soften the Pt.

12.4.7.3 Package and storage

Pack or store assembly as it is.

12.4.7.4 Mounting

Install and adjust height of inner gas supply multibore tube to be perfectly aligned with the top of the sample support, as described elsewhere. Remove support (tube, and disk, if used).

If a gold sealing gasket is to be used, the multibore tube must be aligned taking this extra height into account. Press the tip of the middle finger down in one of the gas holes in the multibore tube, and contact to ILC (3) and ILV (4). Bend the Pt wires close to the top or bottom so as the length fits. Check that the platinum can be easily pressed down into alignment with the support by for instance a sample disk.

12.4.7.5 Use

Use as electrode contact to lower, centre electrode of disk samples.

12.4.8 Electrode contact assembly, general purpose, 2-wire (GP2)

12.4.8.1 Materials

Alumina capillary tube, 2-bore, 47 cm
Pt wire, 0.5 mmØ, 2 x 54 cm

2 female feedthrough contacts

12.4.8.2 Procedure

Cut 2 x 54 cm Pt wire.
Thread both wires.
Solder contacts.

12.4.9 Electrode contact assembly, general purpose, 1-wire (GP1)

12.4.9.1 Materials

Alumina tube, 1-bore, 2 mmØ, 45 cm
Pt wire, 0.5 mmØ, 53.6 cm
1 female feedthrough contacts

12.4.9.2 Procedure

Cut 53.6 cm Pt wire.
Thread wire.
Solder contact.

12.4.10 Contact pair assembly, van der Pauw setup (VDP2)

12.4.10.1 Materials

2 pcs of alumina tubes, 1-bore, 2 mmØ, 50 cm
Pt wire, 0.5 mmØ, 2 x 56 cm
2 female feedthrough contacts

12.4.10.2 Procedure

Thread a Pt wire through a total of 50 cm of 2 mmØ alumina tube.
Lead the end of the electrode contact through the small holes in the contact tubes, then turn once around under the tube, over the top and back through the hole for fixation. Cut Pt wire at 54 cm from the tube.
Repeat for another wire in the pair.

Solder feedthrough contacts.

12.4.10.3 Mounting

With a pair in place in one tube, fix to the contacts in the base unit, and bend the contact wires at the top over the sample so as to make the contact tube and the two point contacts formed by the wire turn around it hit approximately the sample rim. Repeat for the other tube. Then thread the bridging tube through the two centre holes in the contact tubes. Thread the two spring force tubes onto it. The hooking up of the springs may be done before or after this. Fasten the springs (on versions A-1 to A-3 to screws placed over feedthroughs 7 and 14 (one between each electrode pair)). Adjust the distance between the contact tubes so as to get as close to the rim as possible, without risking that one falls off during final assembly of other components, notably the outer tube. We suggest you try to use a distance of 1 mm from the rim. The error caused by this is fairly small – it can be estimated and corrected for or you can establish your own correction factor by measuring with the same error on a standard material.

12.4.11 Guard rings (GR#, #=diameter of ring)

Thread Pt wire through a total of 50 cm of 2 mmØ alumina tube.
Form ring of desired diameter (e.g. 18 mm (GR18) for a 20 mm outer diameter support tube). Welding or crossing at the meeting point is usually not necessary unless the ring shall also have a sealing function.
Cut wire to 53 cm from ring exit.
Solder feedthrough contact.

12.4.12 Guard rings for HV version cell (GR#HV, # - diameter of ring)

Thread Pt wire through a total of 48 cm of 2 mmØ alumina tube.

Form ring of desired diameter (e.g. 18 mm (GR18) for a 20 mm outer diameter support tube). Welding or crossing at the meeting point is usually not necessary unless the ring shall also have a sealing function.

Cut wire to 50.9 cm from ring exit.

Solder HV feedthrough contact.

12.4.13 Electrode nets with 2 contacts (GP2N#, # - diameter of Pt net disk)

12.4.13.1 Materials

Pt net disk of desired diameter

Pt wire, 0.5 mmØ, 7 cm

12.4.13.2 Procedure

Bend Pt wire on the middle around 4 mm diameter tube to form "U". Press 1 cm of legs at 3t. Attach Pt net to the bend and press 1.5 cm at 5t. Heat the flattened area in order to soften the Pt. Bend 90 degrees out sideways just above flat leg part. Bend half of flat leg part back in, leave open grip.

12.4.13.3 Use

Place GP2 or 2 x GP1 electrode contacts in the grip and fasten using pliers.

12.5 Gold gaskets

12.5.1.1 Materials

Use pure gold wire of 0.5 – 1 mm diameter.

12.5.1.2 Procedure

If the gaskets are to be sealed by softening near the melting point they must be welded into rings without use of any solder (NB: goldsmiths typically use a low-melting solder gold alloy).

Example: To make a gold gasket of diameter 18 mm (for use as seal on a 20 mm support tube, cut 0.5 mmØ gold wire to length 5.7 cm. Form circle and weld together using a flame or a laser. Press the ring onto a cone to make it circular. Check diameter vs your tolerances. Press flat using a steel press, but with little force ("handpower" only). Wash in ethanol. **Gold gaskets may be ordered from us.**

12.5.1.3 Use

Check that surfaces to be sealed are smooth and clean. Put gasket in place and apply force evenly. Heat to yield temperature. The smaller the mechanical force, the closer to the melting point you need to go. For the forces conveyed by typical springs in the ProboStat, you normally need to go as close as 1-5 degrees centigrade from the melting point (1064°C). The larger the diameter of the support and ring, the less pressure and the closer you must go. Thus, a 10 mm sample with a 8.5 mm gasket may be "easy" to seal, while a 20 mm or 24 mm sample requires good temperature control and uniformity as well as patience.

Advice on monitoring the sealing is provided under the respective methods in Chapter 8.

13 Selected scientific themes in more detail

13.1 Introduction to impedance spectroscopy of materials

In impedance spectroscopy the impedance is measured over a broad range of frequencies so that different processes with different time constants can be separated from each other. For instance, the method enables one to measure a material's conductivity and permittivity in bulk separate from those across grain boundaries or over electrodes.

Impedance spectroscopy is not straightforward, and teaching it is similarly challenging. In the present short section on the theme we can hardly expect to tutor the beginner, but we hope to provide a useful glimpse and some useful expressions and illustrations for ProboStat users.

13.1.1 Alternating current and impedance

As opposed to direct current (DC), the voltage and the resulting current (or vice versa) to an alternating current (AC) vary as a function of time, most commonly as a sine function. The sine voltage is characterized by its angular frequency ω ($\omega = 2\pi f$, where f is the frequency) and amplitude U_0 :

$$U = U_0 \sin \omega t$$

The term ωt is called the phase angle. The voltage induces a current

$$I = I_0 \sin (\omega t + \theta)$$

Thus, the current is phase shifted by the phase displacement θ .

At a given frequency, the impedance spectrometer measures both the ratio of the voltage and the current, which is termed Z , and the phase angle between the two. These two values (Z and θ) can be used to represent the impedance in a two-dimensional plane spanned by the real and imaginary vector, as visualized in Figure 13-1.

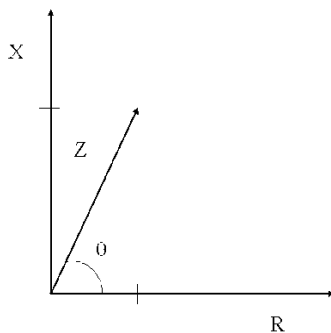

Figure 13-1. Vector representation of the impedance.

The impedance may now be regarded as a vector whose coordinates are R and X . Alternatively, the impedance can be expressed as a complex number $Z^* = R + iX$, where $i = \sqrt{-1}$. The real part of the impedance, R , is called the resistance and the imaginary, X , is called the reactance.

13.1.2 Passive electrical circuit elements and their characteristics

As explained above, the current may be phase shifted with respect to the voltage. The phase displacement depends on the sample through which the current flows. As an approximation, a sample's response on an

alternating current may be explained by use of three passive circuit elements. These are the resistor, the capacitor and the inductor.

13.1.2.1 Resistors

A resistor is a circuit element with long-range transport of charge carriers. When current flows through a resistor, the current and voltage are in phase. The resistance is therefore given as

$$R = \frac{U}{I} = \frac{U_0 \sin \omega t}{I_0 \sin \omega t} = \frac{U_0}{I_0}$$

Because the current and voltage through a resistor are in phase, a resistor contributes to the impedance's real part.

The total resistance of two resistors in series is equal to the sum of the two; $R_{\text{tot}} = R_1 + R_2$. When they are in parallel, the inverse total resistance is equal to the sum of the two inverse resistances, that is

$$\frac{1}{R_{\text{tot}}} = \frac{1}{R_1} + \frac{1}{R_2}$$

13.1.2.2 Capacitors

A capacitor is a circuit element which can store electrical energy as electrical charges. The capacitor becomes charged when a voltage is applied over it. The higher the voltage, the higher charges can be stored. A capacitor's ability to store charges is expressed through its capacitance, which is equal to the ratio of the stored charge and the voltage.

If the voltage over a capacitor is varied periodically, as by means of alternating current, a current will flow through it. The current has a phase displacement of 90° , and will for that reason only contribute to the imaginary part of the impedance. The reactance, X , is a function of frequency, and is given by

$$X = -\frac{1}{\omega C}$$

The total capacitance of two capacitors in parallel is equal to the sum of the two. When they are in series, the inverse total capacitance is equal to the sum of the two inverse capacitances.

13.1.2.3 Inductors

Contrary to the capacitor, which is an ideal isolator, the inductor is an ideal conductor. That means that a capacitor opposes changes in voltage, whereas an inductor opposes changes in current. An inductor may also store electrical energy. An inductor's ability to store energy is expressed through its inductance, which is equal to the ratio of the produced magnetic flux and the current.

If an alternating current flows through an inductor, the voltage will be 90° ahead of the current. For that reason, an inductor will only contribute to the imaginary part of the impedance. However, the frequency dependency of the reactance of an inductor is inverse to that of the capacitor, and is given by

$$X = \omega L$$

The total inductance of two inductors in series is equal to the sum of the two. When they are in parallel, the inverse total inductance is equal to the sum of the two inverse inductances.

13.1.3 Electrical circuits and impedance spectra

Three passive electrical circuit elements were introduced above. Emphasis was given on the elements' impedance frequency dependency. In the following, these elements will be used in series and parallel circuits to generate example model spectra.

Assume a circuit consisting of an inductor and a resistor in series. Expressed as a complex number (remember that $i = \sqrt{-1}$), the total impedance is

$$Z^* = R + i\omega L$$

Then assume a circuit consisting of a capacitor and a resistor in series. Expressed as a complex number, the total impedance is

$$Z^* = R - i \frac{1}{\omega C}$$

Thus, these circuits represented in so-called Nyquist plots will consist of straight, vertical lines as shown in the figures below.

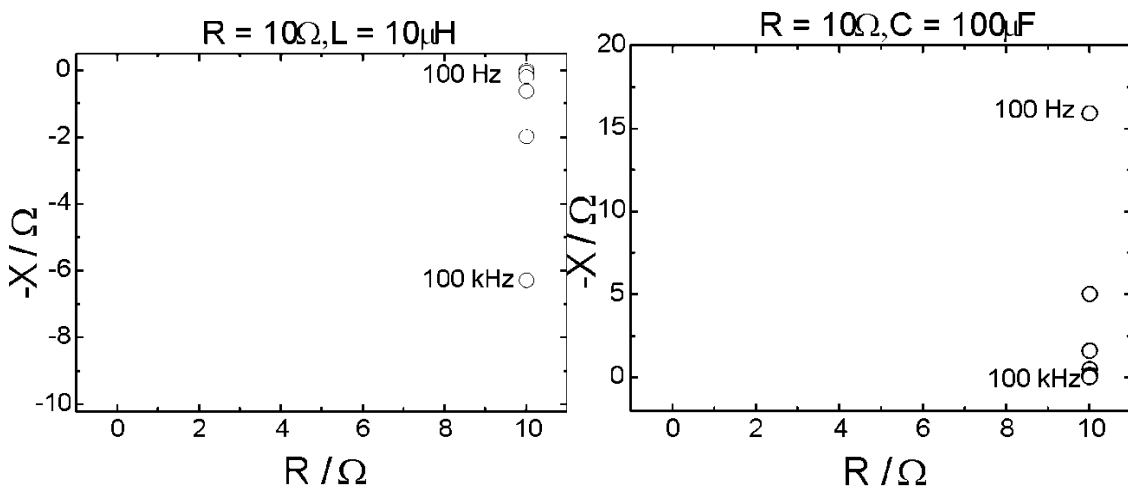

Figure 13-2. Nyquist type impedance plots of series circuits consisting of one resistor and one inductor (left) and one resistor and one capacitor (right).

One may note that in a Nyquist plot, the negative value of the reactance is assigned to the y-axis. As can be seen in the figure, with increasing frequency the inductor's and the capacitor's contribution to the total impedance increases and decreases, respectively.

Next, we consider the same elements in parallel circuits, meaning a resistor in parallel with an inductor and a resistor in parallel with a capacitor. In the case of the series circuits, the Nyquist diagrams consisted of straight lines. The situation is more complex in the parallel case. It may be shown that the total impedance (expressed as a complex number) for the inductor-resistor circuit is

$$Z^* = \frac{\frac{1}{R}}{\left(\frac{1}{R}\right)^2 + \left(\frac{1}{\omega L}\right)^2} - i \frac{\left(\frac{1}{\omega L}\right)}{\left(\frac{1}{R}\right)^2 + \left(\frac{1}{\omega L}\right)^2}$$

and that for the capacitor-resistor circuit is

$$Z^* = \frac{\frac{1}{R}}{\left(\frac{1}{R}\right)^2 + (\omega C)^2} - i \frac{(\omega C)}{\left(\frac{1}{R}\right)^2 + (\omega C)^2}$$

Represented in Nyquist diagrams, the result comprise semicircles for both circuits, as shown in the figures below. The resistor is recognised as the diameter of the semicircles.

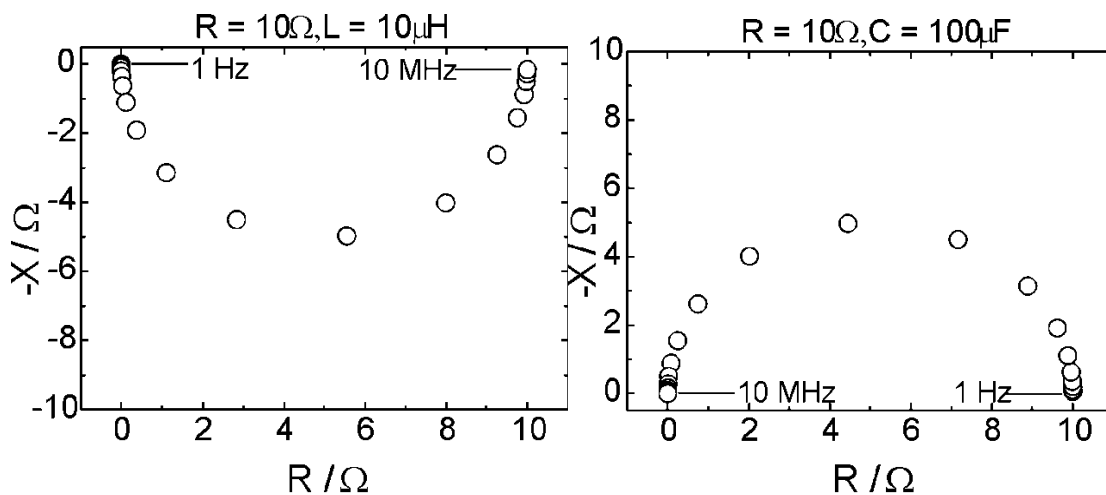

13.1.4 Impedance spectra from real samples

The brief introduction given above gives us a background when we in the following take a look on how impedance spectra from real samples typically are like. When an impedance spectrum is measured, the impedance is usually measured over a wide range of frequency, say from 0.1 Hz to 1 MHz. A spectrum, shown in a Nyquist-type representation, may consist of three semicircles as shown below.

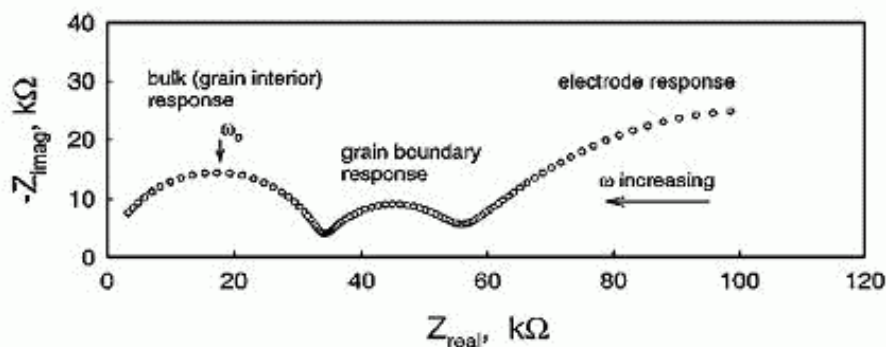

The three semicircles are typically due to contributions from (from left to right) bulk, grain boundaries and the phase boundaries between the electrolyte and the electrode. This response may, as a first approximation, be explained by use of an equivalent circuit consisting of three sub-circuits where each sub-circuit consists of a resistor and capacitor in parallel. It is now useful to introduce the notation commonly applied to describe such circuits. Applied at this specific circuit, it can be written as (RC)(RC)(RC). This terminology uses parentheses when circuit elements are in parallel.

The corresponding frequency at the apex of a semicircle is termed the characteristic frequency, and may be calculated on basis of knowledge of the sub-circuit's resistance and capacitance:

$$f_0 = 1/RC$$

where f_0 denotes the characteristic frequency.

A real polycrystalline sample consists of grain and grain boundaries which are differently with respect to both size and orientation. This difference creates variations in the resistance and capacitance of each grain and grain boundary. The total impedance of the grains therefore reflects a distribution in resistance and capacitance of each contribution. In a Nyquist diagram this is observed as a depressed semicircle, which may be modelled with the constant phase element, the CPE. The impedance of a CPE is

$$Z = \frac{1}{Y(i\omega)^n}$$

where Y and n are constants. If $n = 1$, then the CPE is an ideal capacitor.

Sometimes it is useful to express a capacitor-like CPE as an ideal capacitor: The effective ideal capacitance of a CPE element in parallel with a resistor R can be calculated as

$$C = Y^{1/n} R^{1/(n-1)}$$

13.1.5 Bulk and grain boundaries; the brick layer model

As described in 13.1.4, an impedance spectrum may consist of two semicircles representing the grain interior (bulk) and the grain boundaries of a sample. However, there exist some criteria to be fulfilled in order to observe such a spectrum. In the following these criteria will be given on basis of the model commonly applied to polycrystalline materials, namely the brick layer model.

The figure below shows a polycrystalline sample as visualized in the brick layer model. The model distinguishes between the parallel and series grain boundaries. From simple geometric considerations and assuming that the grain thickness G is much greater than grain boundary thickness g , the total area and length of the two types of grain boundaries may be calculated, and is given in the figure.

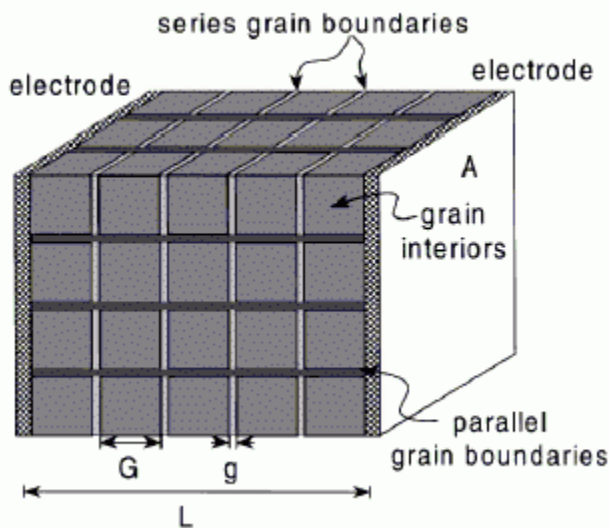

Series grain boundaries:

$$L_{\perp} = (g/G)L$$

$$A_{\perp} = A$$

Parallel grain boundaries:

$$L_{\parallel} = L$$

$$A_{\parallel} = (2g/G)A$$

Principally, the current may flow through the parallel grain boundaries or the grain interiors. In both cases, the charge carriers must traverse the series grain boundaries. Based on this, the equivalent circuit of the left-and side of the figure below is valid. This can be simplified to the circuit given at the right hand side with the appropriate equations for the resistance and the pseudo-capacitance.

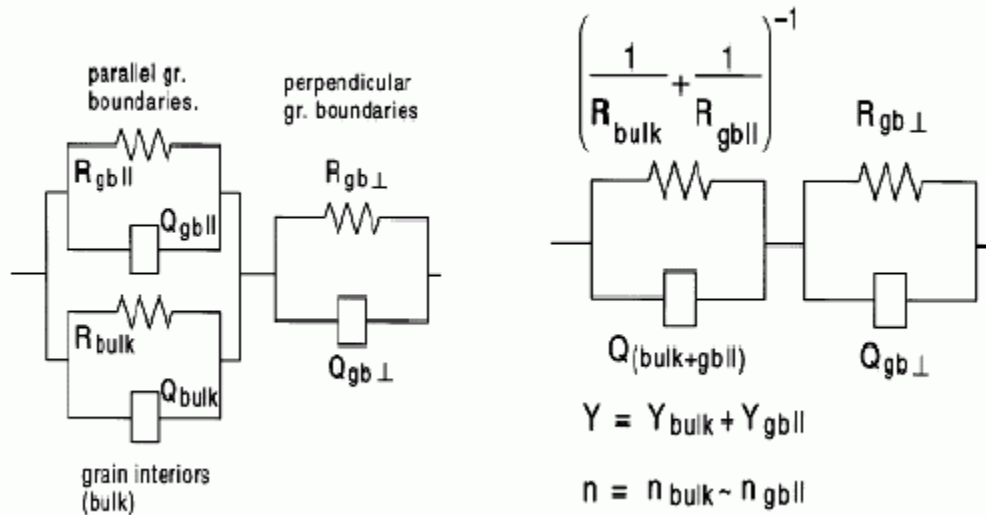

By using the geometrical dimensions given before and the definition $\sigma_i = \frac{L}{AR_i}$ we get the following expressions for the conductivity of the two sub-circuits:

$$\sigma_1 = \frac{2g}{G} \sigma_{\text{gb}} + \sigma_{\text{bulk}}$$

$$\sigma_2 = \frac{G}{g} \sigma_{\text{gb}}$$

These expressions suggest that neither the bulk nor the grain boundary conductivity can be determined from an impedance measurement. However, the situation simplifies if we assess a limiting scenario. We will approach this scenario on basis of the ratio between σ_1 and σ_2 – and therefore R_2 and R_1 – as follows:

$$\frac{\sigma_1}{\sigma_2} = \frac{R_2}{R_1} = 2 \left(\frac{g}{G} \right)^2 + \left(\frac{g}{G} \right) \frac{\sigma_{\text{bulk}}}{\sigma_{\text{gb}}}$$

The expression shows that the relative magnitudes of R_1 and R_2 are both determined by the material's microstructure (g/G) and the electrical properties ($\sigma_{\text{bulk}}/\sigma_{\text{gb}}$). It may be shown (see Haile 1998⁴ for an excellent review on this) that only in the case where $\sigma_{\text{bulk}} > \sigma_{\text{gb}}$ two arcs are observed at high frequencies. This is necessary in order to assure sufficient separation in the semi-circles' characteristic frequencies and sufficient similarity in the size of the semi-circles. When this is the case, $\sigma_{\text{bulk}} = \sigma_1$ and $\sigma_{\text{gb}} = \sigma_2(g/G)$.

To estimate σ_{gb} it seems that knowledge of the material's microstructure is necessary. However, this can be estimated by noting that

$$C_1 \approx C_{\text{bulk}} = \frac{A}{L} \epsilon_{\text{bulk}}$$

⁴ Haile et al. 1998

and

$$C_2 \approx C_{gb,\perp} = \frac{AG}{Lg} \epsilon_{gb}$$

Furthermore, by assuming that $\epsilon_{bulk} = \epsilon_{gb}$, we get that $g/G = C_1/C_2$, and

$$\sigma_{gb} = \sigma_2 \frac{C_1}{C_2}.$$

In spectra where only a single arc is observed at high frequencies, it is impossible to determine σ_{bulk} or σ_{gb} without more information. The resistance associated to this semi-circle is either due to the bulk, the parallel grain boundaries or the sum of those.

13.1.6 Electrodes

When measuring with two- or three-electrode setups, two or one electrode will contribute to the impedance. For ionic conductors, this can often appear like a new (RQ) element giving rise to a new semicircle at low frequencies. If one is mainly interested in the bulk and grain boundary properties, the electrode may be modelled simply as an (RQ) if one includes only the highest frequencies of the electrode response.

For a fuller interpretation of electrode responses on ionic conductors a Randles circuit is often used as a first approach. This is depicted as part of the circuit below.

Electrodes made of electron-blocking materials and electrodes made of mixed ionic-electronic conductors require special treatment, and is beyond the scope of this introduction.

13.1.7 Mixed ionic and electronic conductors

Mixed conducting samples will in the simplest interpretation have an ionic current path with an electrode response included, and an electronic path, without a significant electrode impedance.

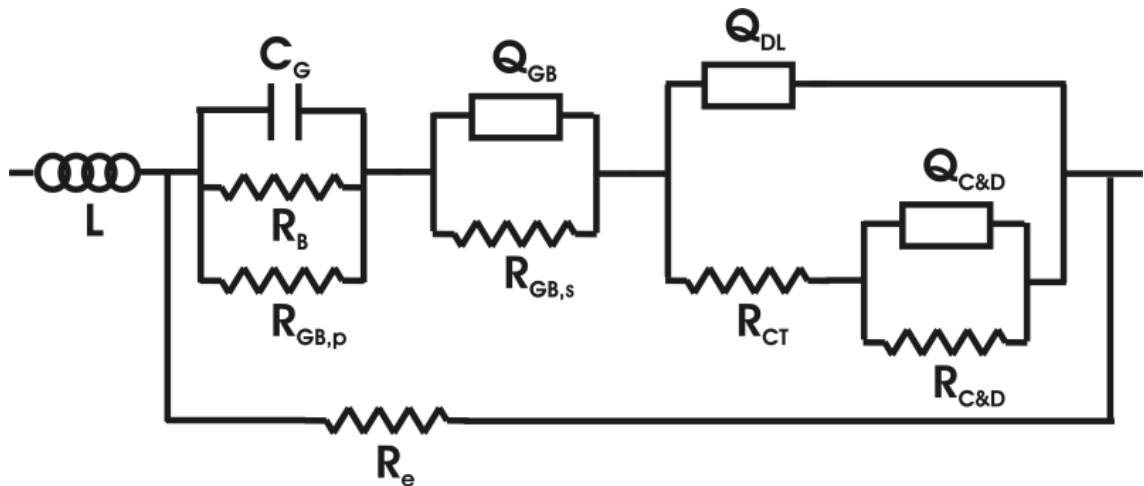

13.2 Seebeck coefficient (thermoelectric power)

13.2.1 Overview

The thermoelectric power is measured by establishing various temperature gradients ΔT over a sample and measuring corresponding voltages $U = \Delta\phi$ over the sample. From a plot of U vs ΔT the Seebeck coefficient is obtained as the slope $Q = dU/d\Delta T$.

By taking the slope in this manner, the offset from origo is eliminated. This offset is typically mainly due to differences in absolute calibration between the two thermocouples or between the temperature at the thermocouple and the electrode. This difference will make the sample have an actual temperature gradient even if the thermocouples indicate zero difference. This common and otherwise serious error is largely eliminated by taking the slope of two or more points and thus avoiding the use of origo.

Next, one needs to add to the measured Seebeck coefficient the Seebeck coefficient of the wire materials. For this reason it is very important to understand the sign conventions and to apply during measurement and correction. The following sections cover these matters.

13.2.2 The sign convention

The Seebeck coefficient or thermoelectric power is the derivative of voltage vs temperature, i.e. the voltage over a sample per degree of temperature difference. It is to be measured such that it becomes positive if the charge carriers are positive and vice versa. One gets the right sign if measuring the voltage at the colder contact vs the hotter contact.

Note that the ProboStat often has the hotter side up and colder down, while it measures the voltage at the top electrode vs the lower electrode. It will in this case get the opposite sign of the convention above, and one then has to reverse the sign of the measured voltage, or reverse the sign of the temperature difference, or reverse the electrode contacts.

Whichever setup you use: If the colder electrode is positive the material is dominantly a conductor by positive charge carriers (e.g. electron holes, protons, interstitial cations like lithium, or oxygen vacancies). If the colder electrode is negative, it is predominately a conductor by negative charge carriers (electrons, cation vacancies, oxygen interstitials, etc.)

13.2.3 Correction for the wire materials

The measurement is done by a pair of wires of the same material, typically Pt. This adds a thermoelectric force to the circuit opposite that of the sample, since it has a part of it in the same temperature gradient as the sample, just in the opposite direction. Thus, if the sample is an n-type conductor and the wires are *similarly* of an n-type conductor (as is the case of Pt), then the Pt will *lower* the absolute value of the measured voltage. We therefore obtain the thermoelectric force of the sample material by *adding* the thermoelectric force of Pt at the average sample temperature. If the sample material is a p-type material, then we correspondingly get a lower thermoelectric force when we correct measured result by adding the negative power of the Pt.

All in all, and very simply: You correct the measured thermoelectric power obtained as the voltage at the cold vs the hot electrode, divided by the temperature difference, by *adding* the thermoelectric power (with the appropriate sign) of the wire material.

The published thermoelectric power of Pt has been fitted to a polynomial function of $T(K)$ of the form

$$Q_{Pt}(\mu V/K) = a + bT + cT^2 + dT^3 + eT^4 + fT^5 + gT^6$$

and the parameters $a - g$ are

A	12.90193079
B	-0.103901738

C	0.000207622
D	-2.53572E-07
E	1.68872E-10
F	-5.76676E-14
G	7.89335E-18

13.3 Voltage measurements on high impedance samples

Measurements of voltage of a high impedance sample has two main problems; the voltmeter's input impedance, and the parasitic shortcircuiting conduction paths of the cell and wiring. Both have the effect of drawing current from the sample over its impedance, thereby reducing the measured voltage.

13.3.1 Use of an electrometer

An modern electrometer is a high impedance voltmeter designed to handle the two problems. Its high impedance – typically 10^{12} ohm or higher – is sufficient to not draw significant currents from most samples.

Secondly, it has a guard contact. This should be connected to the shield system of the ProboStat which should be as extensive as possible shielding the two electrode wiring sets from each other. Naturally, the shield comprises the ProboStat chassis and measurement wire shields. If possible one may also use a conducting support tube and guard it to further reduce the parasitic currents.

The way the guarding of the shields work is that the electrometer puts the shield system to the same potential as one of the electrodes, thus hindering any current to flow between that electrode and the shield.

13.3.2 If you don't have an electrometer

13.3.2.1 Understand the difference between measured sample impedance and actual measurement system (cell) impedance

Let us say that a sample DC impedance is $100\text{ M}\Omega$, as measured by an impedance spectrometer. The cell impedance (insulation between electrode connectors and the chassis and shield system, and thus between two electrode connectors) may still be only for instance $1\text{ M}\Omega$. The impedance spectrometer obtained the correct result by using its guard function to eliminate current flowing through the chassis and shields.

If you want to measure the voltage over a high impedance sample, you may have to take these aspects into account. For instance, the $1\text{ M}\Omega$ cell impedance will shortcircuit the sample's $100\text{ M}\Omega$ and reduce the measured voltage to only $1/100$ of its true open circuit value, even if your voltmeter has an input impedance of – say – $100\text{ G}\Omega$.

To minimise this problem you must either increase the cell impedance by reducing the possibility of conduction between electrode contacts through shields etc. *or* use an electrometer – a voltmeter with very high input impedance and – more importantly – a guard terminal that does exactly the same as the guard of the impedance spectrometer; eliminate any current flowing through the guarded shield system.

13.3.2.2 Increase cell impedance (reduce chassis and shield conduction paths)

In order to use a voltmeter without guard one must then try to reduce parasitic conduction paths between the electrodes. Avoid shields that contact each other. have dry clean surfaces, etc.

14 Schematics, drawings, inlays, etc.

This section contains a few pages, which are used as quick-references, inlays etc. in the manual and elsewhere

Identification and specifications

The following identifies a particular cell and a few essential specifications – an important source of information for safe and accurate operation. This page appears as a blank template at the end of the manual. A filled-in version follows the files for each cell, e.g. in the cover of the manual. If you make changes to the cell, correct the original table or fill in this blank copy. If you obtain new copies of the manual, be sure to keep the filled-in version of this page.

Cell type:

Serial number:

Altered:

To (new version):

By:

Part	Material, type	Marking	Manufacturer, quality
Hot zone wiring Thermocouple type Thermocouple positive Thermocouple negative General/electrode			
Connector box wiring Thermocouple positive Thermocouple negative General/electrode			
External wiring Compensation cables Thermocouple positive Thermocouple negative General/electrode			
Base unit assembly			
Metal gas tubes			
External gas connects			
Main ceramics			
O-rings			
Support tube glues			
Multi-connector			
BNC bulkheads			
Toggle switches			
Div.:			
Diverse parts			

Wiring overview (all figures are top views)/S-Type



Overview of base unit feedthroughs and gas supply.*

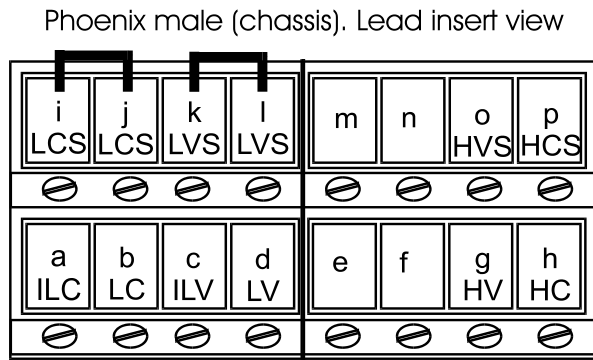

Front face - screw access side

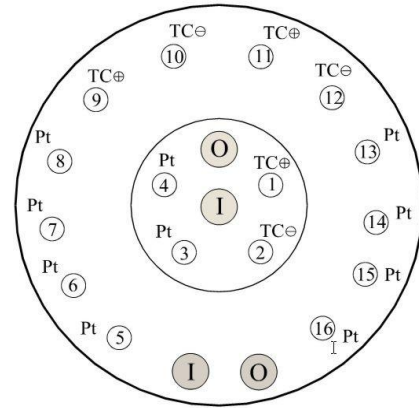

gas gas

Standard electrical wiring of ProboStat versions A-2 and later, using **S-type thermocouples**.

Base unit feed-through code	Base unit feedthrough colour code	Standard material in hot zone	Function	Function code	Phoenix rectangular multi-connector (optional) code	BNC code (S = shield)	Thermocouple contact codes
1 P	Black	Pt10Rh	Bottom/inner TC+	TCB+	-	-	TCB+
2 N	Red	Pt	Bottom/inner TC-	TCB-	-	-	TCB-
3 G	-	Pt	Inner low current	ILC	a	ILC	-
4 G	-	Pt	Inner low voltage	ILV	c	ILV	-
5 G	-	Pt	Low current shield	LCS	i,j	LCS	-
6 G	-	Pt	Low current/Guard	LC	b	LC	-
7 G	-	Pt	Low voltage shield	LVS	k,l	LVS	-
8 G	-	Pt	Low voltage	LV	d	LV	-
9 P	Black	Pt10Rh	Top TC+	TCT+	-	-	TCT+
10 N	Red	Pt	Top TC-	TCT-	-	-	TCT-
11 P	Black	Pt10Rh	Centre/control TC+	TCC+	-	-	TCC+
12 N	Red	Pt	Centre/control TC-	TCC-	-	-	TCC-
13 G	-	Pt	High voltage	HV	g	HV	-
14 G	-	Pt	High voltage shield	HVS	o	HVS	-
15 G	-	Pt	High current	HC	h	HC	-
16 G	-	Pt	High current shield	HCS	p	HCS	-

Switches: Ch+HCS: Chassis to shield (HCS), LC+HCS: Guard (LC) to shield (HCS) **when DOWN**.
Shields Br.: Connects all four shields together **when DOWN**.

- * For the following base units, the outer **In** and **Out** gas paths (on the outer circle) are swapped:
- version A1/A2 (all),
 - version A6, no. 15301-15305, 15307, 16001, 16301, 16302,
 - version B6, no. 15301-15303, 15306.

Wiring overview (all figures are top views) /K-Type

NORECS

Overview of base unit feedthroughs and gas supply.*

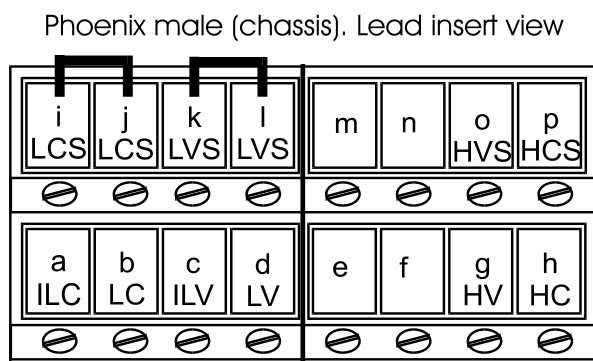

Front face - screw access side

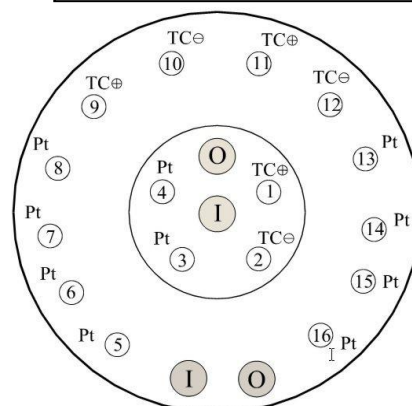

gas gas

Standard electrical wiring of ProboStat versions A-2 and later, using K-type thermocouples.

Base unit feedthrough code	Base unit feedthrough colour code	Standard material in hot zone	Function	Function code	Phoenix rectangular multi-connector code	BNC code (S = shield)	Thermocouple contact codes
1 P	Green	NiCr	Bottom/inner TC+	TCB+	-	-	TCB+
2 N	White	NiAl	Bottom/inner TC-	TCB-	-	-	TCB-
3 G	Red	Pt	Inner low current	ILC	a	ILC	-
4 G	Red	Pt	Inner low voltage	ILV	c	ILV	-
5 G	Red	Pt	Low current shield	LCS	i,j	LCS	-
6 G	Red	Pt	Low current/Guard	LC	b	LC	-
7 G	Red	Pt	Low voltage shield	LVS	k,l	LVS	-
8 G	Red	Pt	Low voltage	LV	d	LV	-
9 P	Green	NiCr	Top TC +	TCT+	-	-	TCT+
10 N	White	NiAl	Top TC -	TCT-	-	-	TCT-
11 P	Green	NiCr	Centre/control TC+	TCC+	-	-	TCC+
12 N	White	NiAl	Centre/control TC-	TCC-	-	-	TCC-
13 G	Red	Pt	High voltage	HV	g	HV	-
14 G	Red	Pt	High voltage shield	HVS	o	HVS	-
15 G	Red	Pt	High current	HC	h	HC	-
16 G	Red	Pt	High current shield	HCS	p	HCS	-

Switches: Ch+HCS: Chassis to shield (HCS), LC+HCS: Guard (LC) to shield (HCS), **when DOWN.**
Shields Br.: Connects all four shields together **when DOWN.**

- * For the following base units, the outer In and Out gas paths (on the outer circle) are swapped:
- version A1/A2 (all),
 - version A6, no. 15301-15305, 15307, 16001, 16301, 16302,
 - version B6, no. 15301-15303, 15306.

Do's and Don'ts

Ensure that gas line have **overpressure relief** that prevents supply of unintended gas overpressure.

Wear **eye-protection** if working with explosive or flammable gases.

If you have Stainless steel (SS) gas connects: Use SS ferrules for SS tubing, brass ferrules for copper tubing. If you have brass (B-) gas connects: Use only **copper tubing and brass ferrules**.

Ensure that gas connect **stems with valves** (the long ones) are used **on bulkheads with valves** (normally IN connects).

Ensure that metal parts of cell are at no risk of contacting **high-voltage-carrying parts of the furnace**.

Check that your **water-cooling system** is fail-proof.

Use the appropriate **thermocouple type**. Check proper functioning (polarity) of your controlling thermocouple during initial heating. **Warning:** Colours red and black (for type S Pt/PT10Rh thermocouples do *not* mean positive and negative as is normal for multimeter cables!

Always fasten and secure the cell so that it cannot fall over. Use a stand & mounting ring when possible.

Don't neglect the functions and proper setting of the **ProboStat's switches**. Switches **connect when down**.

Consider keeping a backup of vulnerable ceramic parts of the cell to avoid downtime should something accidentally break.

Don't close ProboStat cases unless all layers & foams are in place. (Otherwise, someone may stow it, and ceramic parts will fall down and crack.)

Don't hesitate to ask us:

Email: post@norecs.com

Tel: +47-22958623

Fax: +47-22604427